



NTSC U/C

WING COMMANDER[®]

Heart of the Tiger[™]

PlayStation[™]



SLUS-00019



WARNING: READ BEFORE USING YOUR PlayStation GAME CONSOLE.

A very small percentage of individuals may experience epileptic seizures when exposed to certain light patterns or flashing lights. Exposure to certain patterns or backgrounds on a television screen or while playing video games, including games played on the PlayStation game console, may induce an epileptic seizure in these individuals. Certain conditions may induce previously undetected epileptic symptoms even in persons who have no history of prior seizures or epilepsy. If you, or anyone in your family, has an epileptic condition, consult your physician prior to playing. If you experience any of the following symptoms while playing a video game – dizziness, altered vision, eye or muscle twitches, loss of awareness, disorientation, any involuntary movement, or convulsions – IMMEDIATELY discontinue use and consult your physician before resuming play.

WARNING TO OWNERS OF PROJECTION TELEVISIONS:

Still pictures or images may cause permanent picture-tube damage or mark the phosphor of the CRT, avoid repeated or extended use of video games on large-screen projection televisions. Refer to your projection TV instruction manual for more details.

HANDLING YOUR PlayStation DISC:

- This compact disc is intended for use only with the PlayStation game console.
- Do not bend it, crush it or submerge it in liquids
- Do not leave it in direct sunlight or near a radiator or other source of heat.
- Be sure to take an occasional rest break during extended play.
- Keep this compact disc clean. Always hold the disc by the edges and keep it in its protective case when not in use. Clean the disc with a lint-free, soft, dry cloth, wiping in straight lines from center to outer edge. Never use solvents or abrasive cleaners.

This product has been rated by the Entertainment Software Rating Board. For more information about the ESRB rating, or to comment about the appropriateness of the rating, please contact the ESRB at 1-800-771-3772.

TABLE OF CONTENTS

Playguide	2	Targeting	19
Starting Play	2	Target Lock	19
The Controller	3	Smart Targeting	19
Symbol Definitions	3	Inertial Targeting and	
Starting the Game	4	Tracking System (I.T.T.S.)	20
On the Carrier	4	Missile Lock	20
Maneuvering Your Ship	4	Cloaking	20
Saving, Loading and Exiting	4	Dying	21
Quick Start	5	Ejecting	21
Option Screen	5	In-Flight Options	21
Onboard the <i>Victory</i>	5	Main Terminal Options.....	22
Main Terminal.....	5	Transfer Information	23
Talking to Characters	6	Intell Report: Kilrathi Aces	23
Lift.....	6	Pilots of the Month	24
Bridge	6	Lieutenant Laurel Buckley	24
Gunnery Control.....	7	Lieutenant Winston Chang	25
Rec Room.....	7	Lieutenant Mitchell Lopez	25
Berths	8	Major Todd Marshall.....	26
Flight Control	8	Lieutenant Robin Peters	26
Simulator	9	The Secret of the Excalibur	27
Loadout Terminal	9	GIF: Ship Statistics	29
Mission Briefing Room	10	Statistical Definitions	29
In the Cockpit	10	Confederation Fighters	30
Cockpit Instruments	10	Confederation Capital Ships	32
Viewscreen	11	GIF: Kilrathi Ship Statistics.....	34
Radar Display	11	Kilrathi Fighters	34
Gunsight	12	Intell: Enemy Fighter Update	37
Left VDU	12	Kilrathi Capital Ships	37
Right VDU	14	Shields	37
Weapon VDU	15	Weak Points	37
Active Gun/Active Missile	15	Best Ordnance	38
Gun Power Indicator	16	GIF: Gun and Missile Statistics	40
Fuel Indicator	16	General Ordnance Information	40
Autopilot Light.....	16	Energy Guns.....	40
Speed Indicators	17	Missile Weapons	43
Missile Lock Light	17	Capital Ship Weapons	46
Jumping	17	Credits	47
Takeoffs and Landings.....	18		
Navigation.....	18		

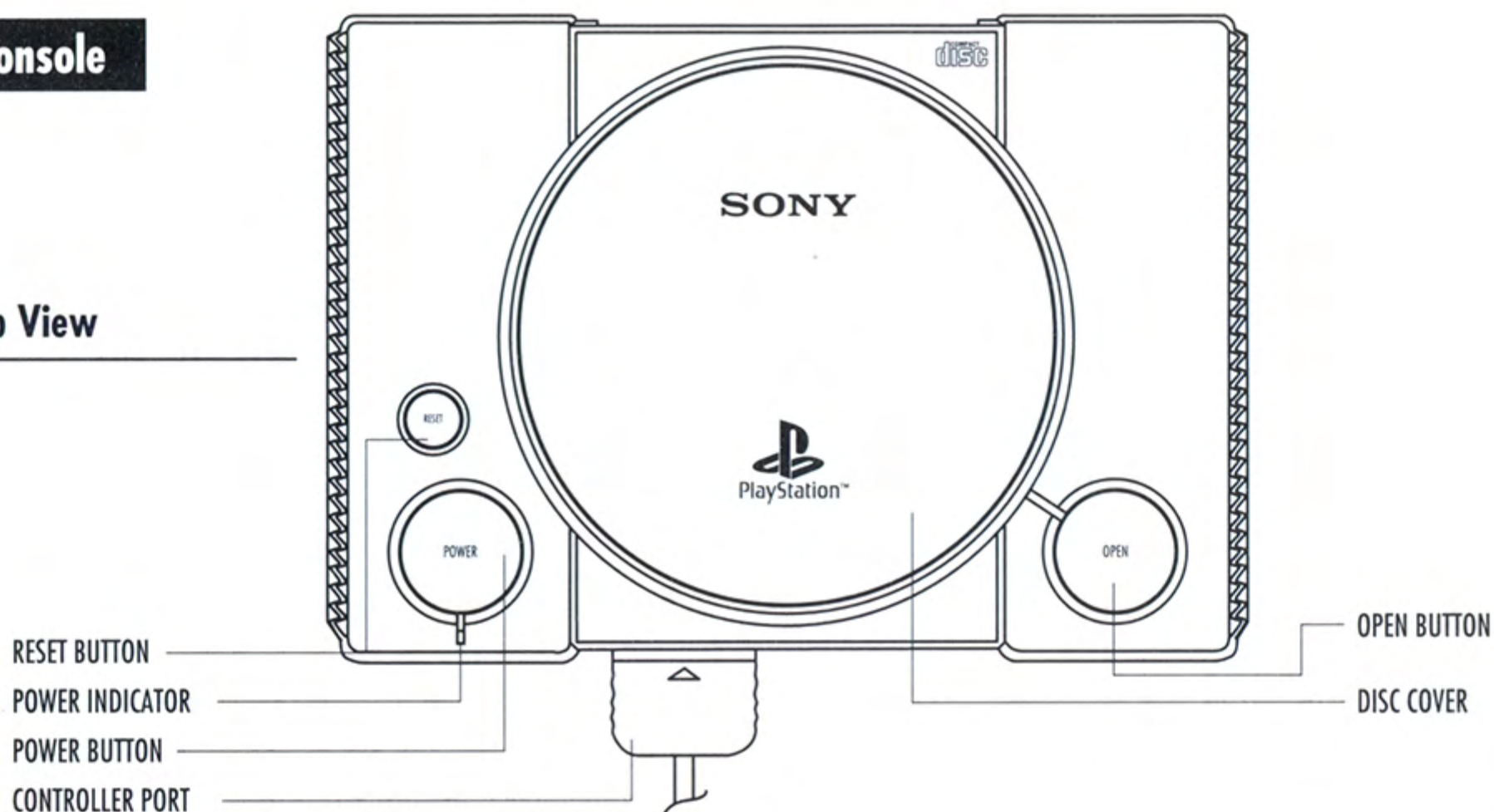
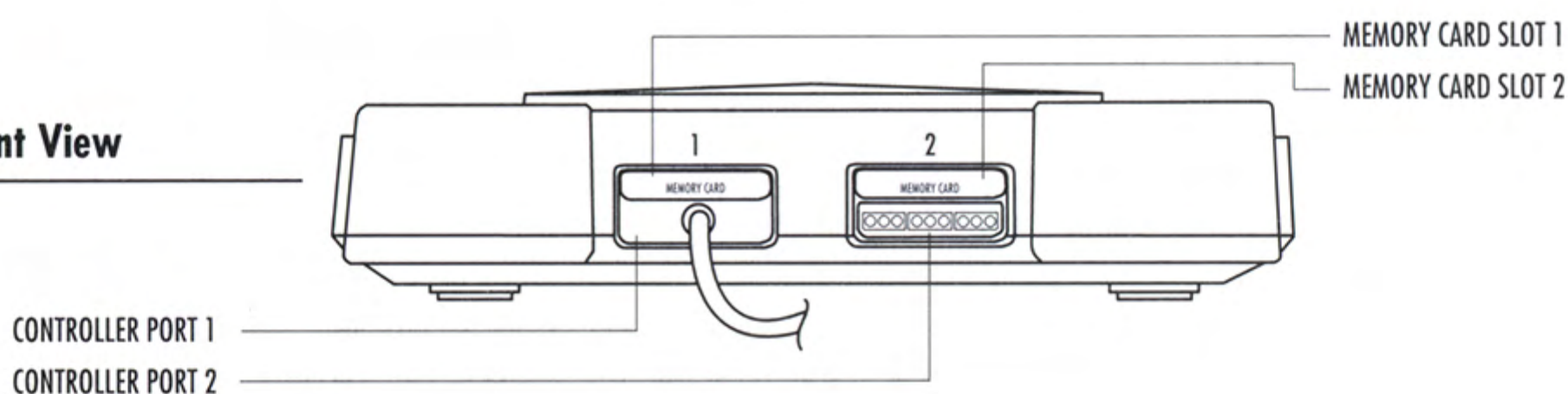
Console**Top View****Front View**

STARTING PLAY

Set up your PlayStation game console according to the instructions in its Instruction Manual. Make sure the power is off before inserting or removing a compact disc. Insert the *Wing Commander III Disc #1* and close the CD door. Insert game controllers and turn on the PlayStation game console. Follow on-screen instructions to start a game.

Front View

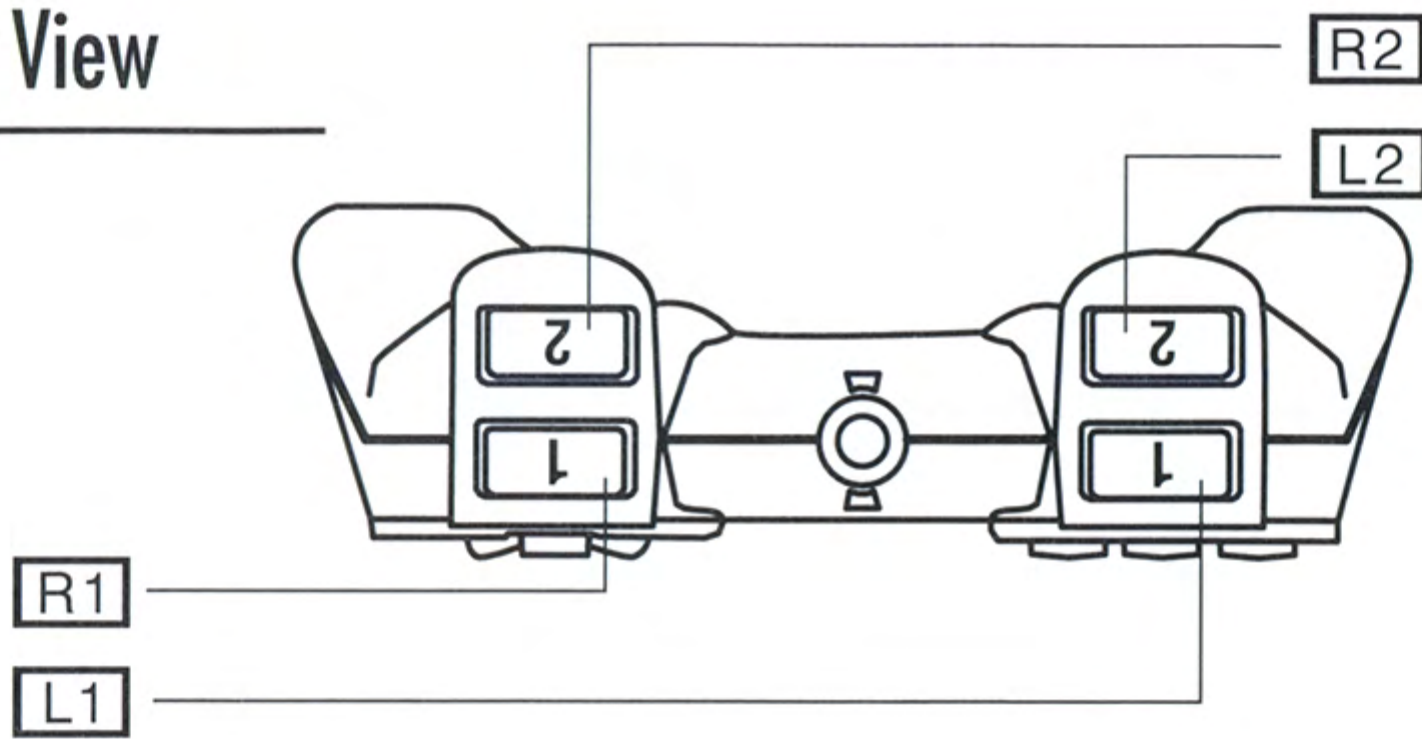

Top View

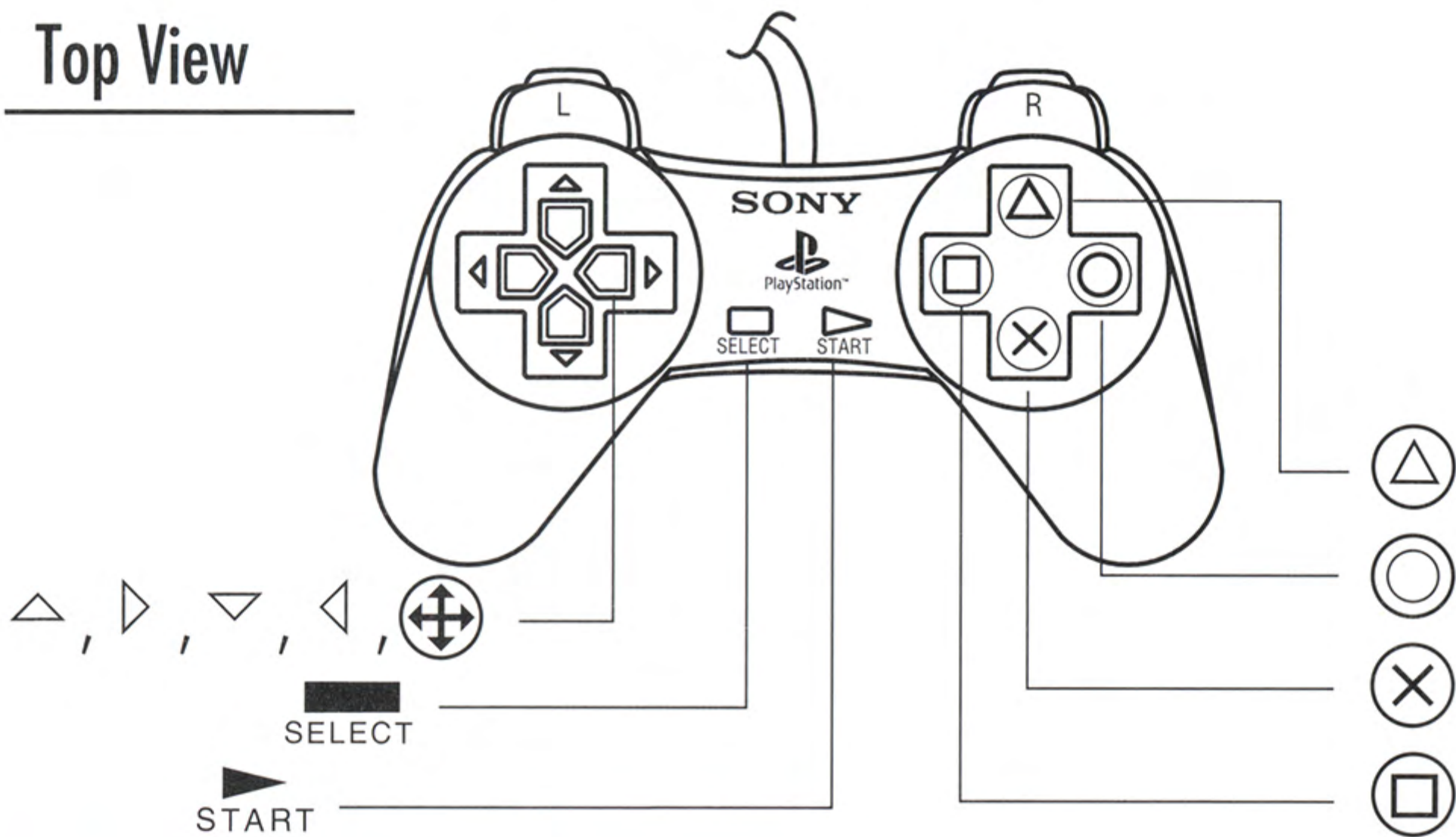



THE CONTROLLER

You use the PlayStation controller to move your cursor and fly your ship. The following diagrams show the controls on the PlayStation controller. Please see the reference card for a complete listing of all commands.





SYMBOL DEFINITIONS

- ◻ Press the indicated key once.
- ⬆️ Move the Direction Buttons (D-buttons) to change options (on the carrier); change the nav map view and steer your ship (during flight). The symbols ⬆️, ⬅️, ⬆️ and ⬇️ indicate specific directions when moving the D-buttons.
- ⓧⓂ️ Press and hold the first button, followed by the second button. Here, you would hold down ⓧ while pressing Ⓜ️.

STARTING THE GAME

After you turn on the PlayStation game console, the game will play an introductory scene. (To bypass movies, press ) Later, you can press and hold   for two seconds to restart the game.

ON THE CARRIER



 *Choose an action.* Move the D-buttons () to position the cursor over an object or person. Alternatively,  or  on the controller cycles through action spots on the screen. You'll see the option on the screen — for example, *Talk to Hobbes, Go to Lift, Attend Briefing, Activate Main Terminal*, etc.

Note: You can toggle onscreen text on and off through the Main Terminal (see **Main Terminal Options**, p. 22).

 *Begin selected action.* Press  to activate the option you've chosen.

MANEUVERING YOUR SHIP









During flight, press  or  on the controller to move your ship up or down. Press  or  to bank right or left.

To roll your ship right or left along its axis without changing course, press  or .

To increase the speed of your climb, dive or turn, press and hold  in addition to the normal button.

SAVING, LOADING AND EXITING



You can only save from the carrier or from a depot. (You must have a memory card inserted in one of the memory slots.) Go to Flight Control, the Berths, Gunnery Control or the Bridge and choose the Main Terminal (see p. 5). Then, choose DUTY LOGS.







Saving games. Select SAVE to highlight the first available game slot. Use  or  to cycle through slots, then press  to select the highlighted save game slot. Next, enter a name by pressing  or  to cycle through letters, and  or  to change the cursor position. Press  to save the name, series, mission number, number of kills you've accumulated and the ship morale level. You can save up to 15 games.

Loading saved games. Select LOAD to highlight the first available game slot. Use  or  to cycle through slots, then press  to load the highlighted save game.

Whenever you insert CDs #2, #3 or #4 into the PlayStation game console before turning the PlayStation game console on, a Main Terminal screen automatically appears. This allows you to load save games. To start a new game, you must insert CD #1 in the game console before turning it on.

QUICK START

When the game begins, you're on the Flight Deck. Move the cursor around on the screen. When text appears and/or the cursor changes shape, press  to perform that action. Move the cursor up/down (, ) to choose responses during conversations. To go directly into a mission, select "Attend BRIEFING" on the Flight Level. However, we recommend that you follow these steps before entering your first mission:





1. **Go to FLIGHT CONTROL.**
2. **Talk to HOBBS** (move the cursor over him and press .
3. **Go to LIFT.**
4. **Go to LIVING LEVEL** (choose the green box) and watch the scene between Cobra and Hobbes.
5. **Talk to VAGABOND.**
6. **Go to LIFT.**
7. **Go to BRIDGE LEVEL** (choose the red box).
8. **Talk to MANIAC.**
9. **Go to GUNNERY CONTROL.**
10. **Talk to FLINT.**
11. **Go to LIFT.**
12. **Go to FLIGHT LEVEL** (choose the yellow box).
13. **Attend BRIEFING.** Then, you'll brief the pilots and choose a wingman. Hobbes is your only choice now. Later, you can select anyone you've talked to that is still alive.
14. **Talk to RACHEL** about ship loadouts.
15. **Fly MISSION** to enter the launch bay and take off. Increase the throttle (press ) or press     for an auto-takeoff. (Refer to pp. 10-17 for cockpit instrumentation.)

OPTION SCREEN

Open the option screen by pressing  during spaceflight. For a complete list of options, see **In-Flight Options**, p. 21.

ONBOARD THE VICTORY

MAIN TERMINAL

Main Terminals are present on each level. When you click on a terminal for the first time, you must enter your callsign. To enter your name, press  or  to cycle through the letters of the alphabet. Then, press  or  to move to the next letter slot. (You can enter up to 10 characters.) When you're finished, press . Each time after this, selecting a terminal console displays a close-up of the computer, with a

menu onscreen. Move the cursor over the option you want, then press \otimes . To cancel the screen, choose LOGOFF.

For a complete description of Main Terminal options, see p. 22.

TALKING TO CHARACTERS

To talk with someone you meet, move the cursor over that person and press \otimes . Sometimes, the game pauses and displays two choices. Use \triangle or ∇ to choose an answer, then press \otimes . Certain responses raise individual or group morale, and others lower it. Morale, in turn, affects the plot.

LIFT

The Lift transports you between the *Victory's* three decks.

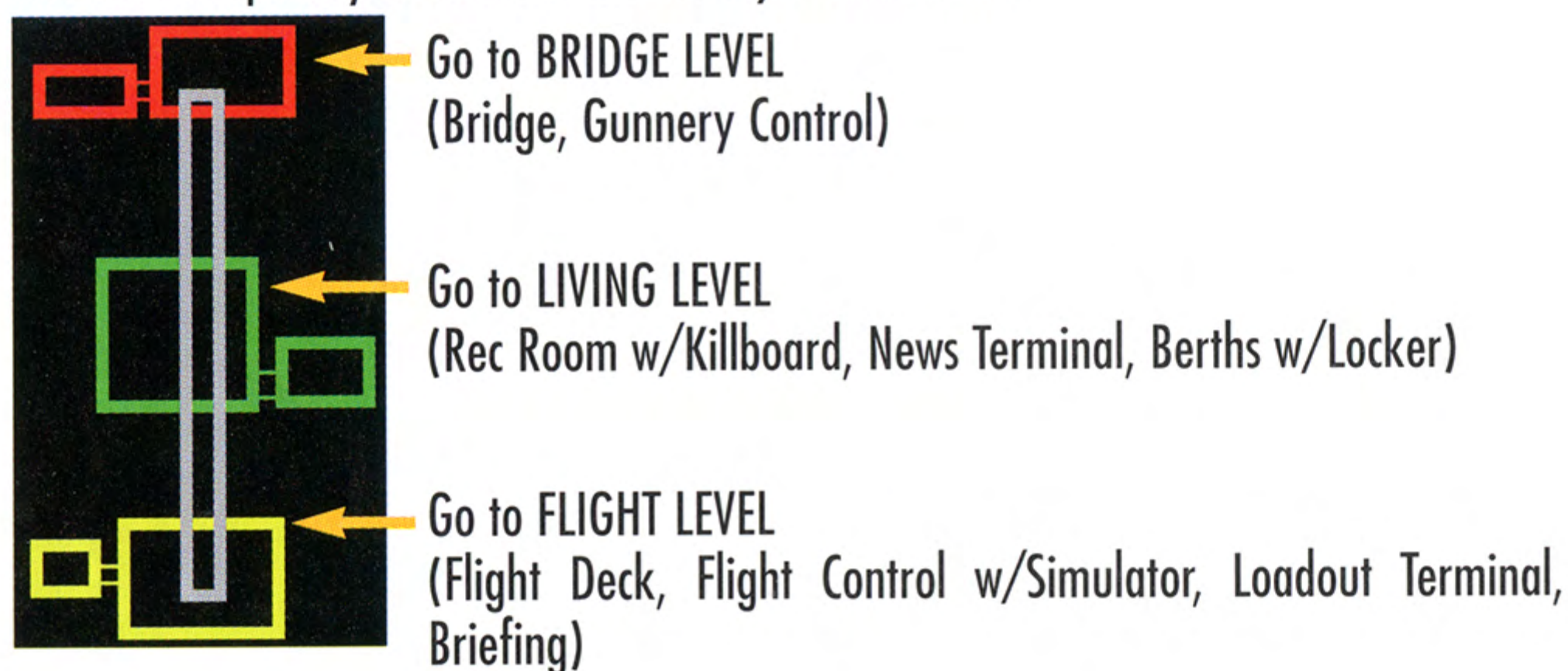

BRIDGE

The Bridge is the center of all *Victory* operations and houses a Main Terminal. From here, you can access both the Lift and Gunnery Control (which also has a Main Terminal).

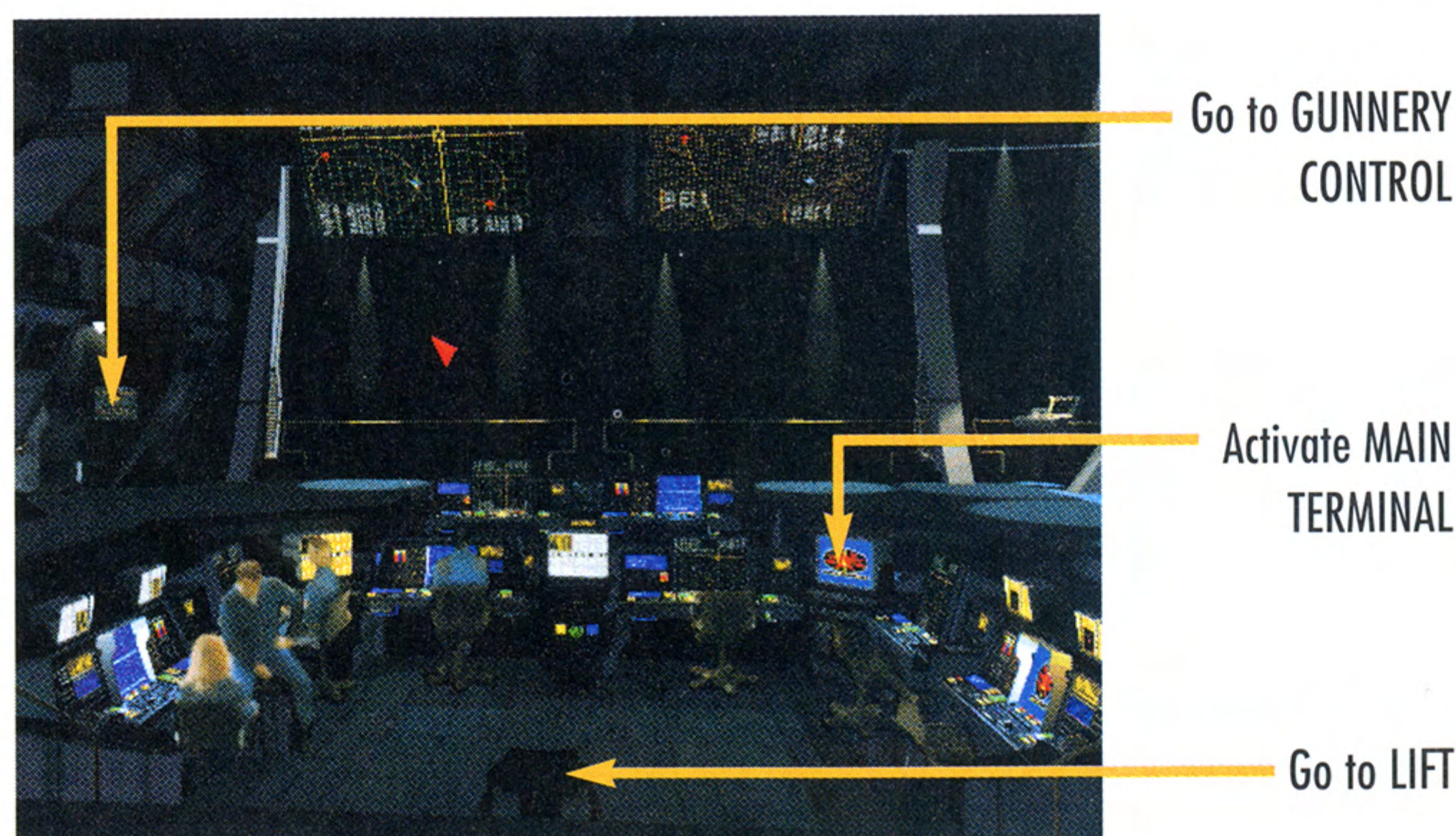

GUNNERY CONTROL

In Gunnery Control, you'll often find your crewmates pondering the stars. Here, you also have access to a Main Terminal and the Bridge.



Activate MAIN
TERMINAL

Go to BRIDGE

REC ROOM

The Rec Room lounge is a common hangout for off-duty crew members. Here, you can discuss strategies with other pilots, access the barracks, check the Killboard or watch the news.

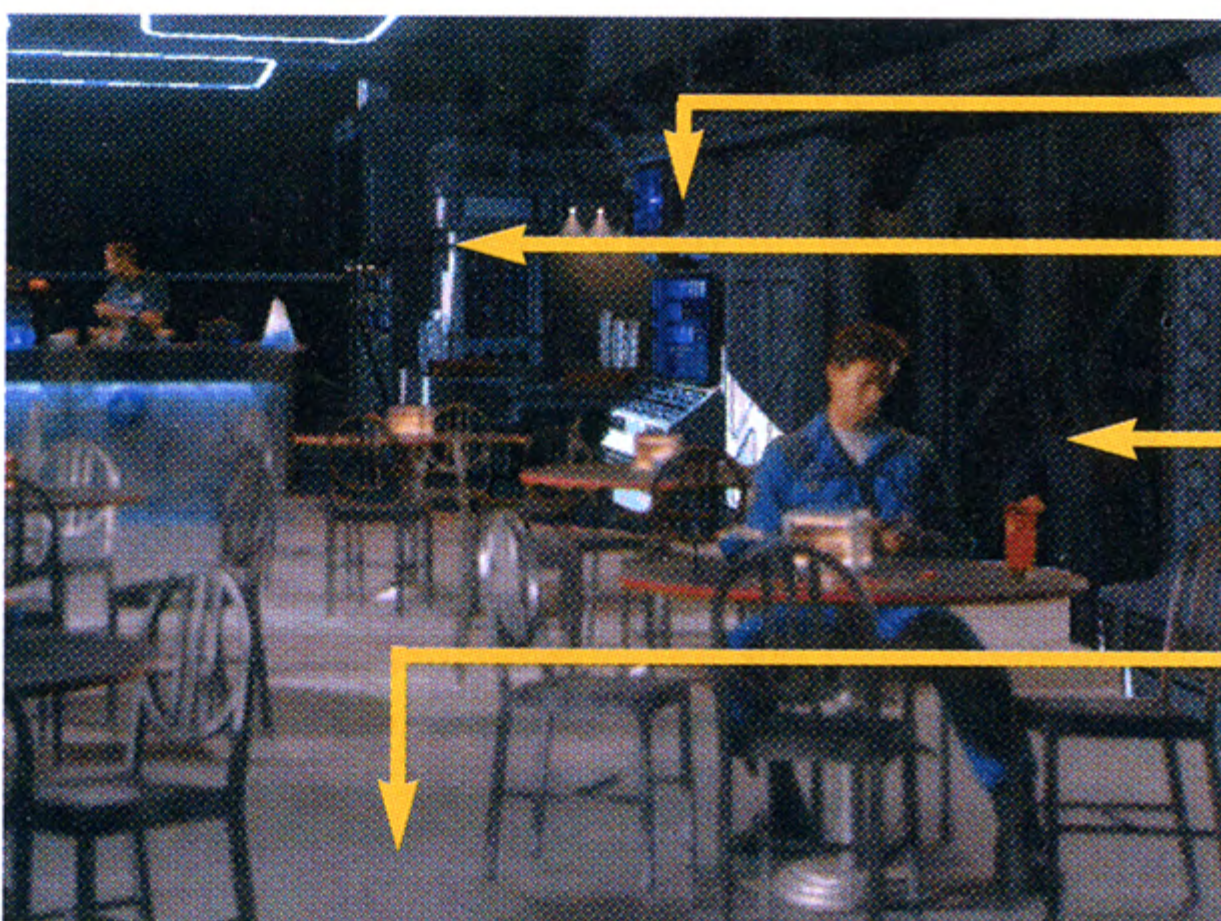

Look at KILLBOARD

Activate NEWS TERMINAL

Go to BERTHS

Go to LIFT

Talk to characters

(those present change during the game)

News Terminal. The News Terminal in the Rec Room broadcasts news briefings throughout the game to keep you informed about the progress of the war. You can use the News Terminal only at certain times, and the newscasts change as the game progresses.

Killboard. The Killboard Terminal in the Rec Room displays the number of kills for each surviving pilot. Your name is last on the list, and as you destroy enemy fighters, the number in your "Kills" column increases. The number of ace Kiltrathi pilots killed by each pilot displays in the "Ace" column. Dead pilots appear as "Deceased."

BERTHS

With its standard cot-and-locker arrangements, the *Victory's* Berth room is sparse but functional. You can activate a Main Terminal, look in your Locker or talk with other pilots who may appear.

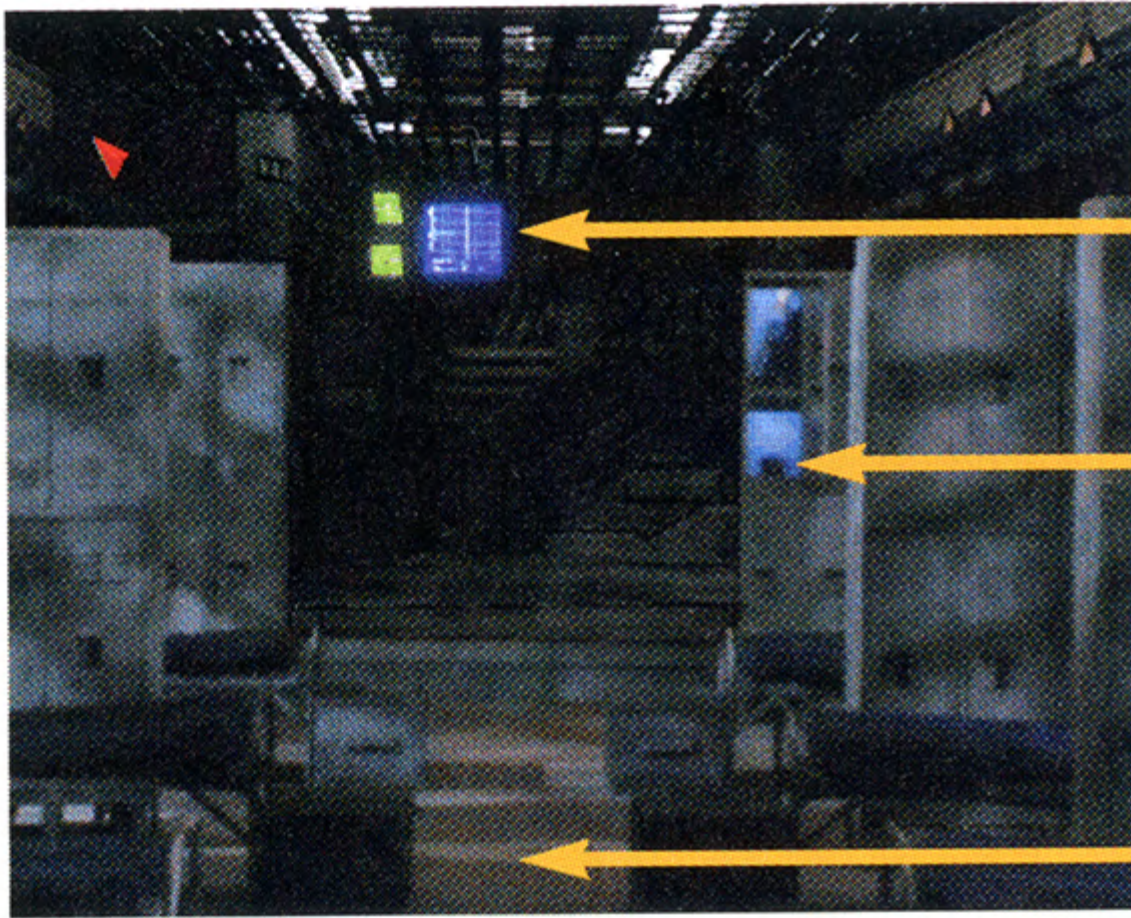

Activate MAIN TERMINAL

Look in LOCKER

(it will be open when available)

Go to REC ROOM

FLIGHT CONTROL

In Flight Control, you can attend mission briefings, use a Main Terminal, fly simulator missions and take the stairs down to the Flight Deck. After your first mission, you have the option of using the Loadout Terminal in Flight Control to pick a ship and its loadout. Once you view the mission briefing, you can't use the Lift, but the Loadout Terminal becomes available.

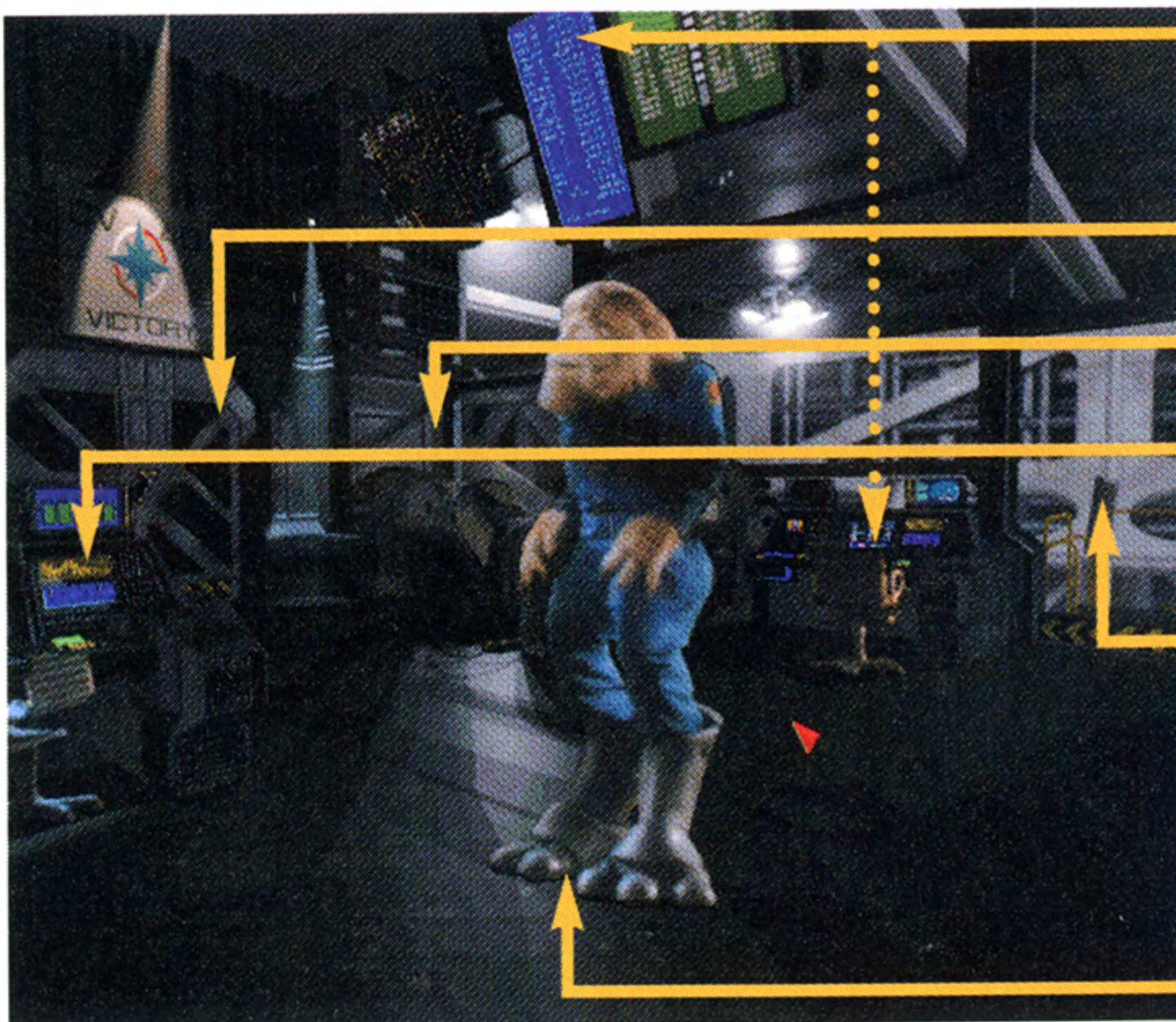

Activate MAIN
TERMINAL

Attend BRIEFING

Run SIMULATOR

Activate LOADOUT
TERMINAL

Go to FLIGHT DECK
or Fly MISSION

(text switches once you
attend the briefing)

Go to LIFT

SIMULATOR

You can use the simulator to brush up on your flying skills.

Move the cursor over the chair and press **X** to display the simulator screen. Press the buttons (using the controller) to configure and start the mission.



ARROWS Select mission. **RUN** Begin simulation. **RETURN** Exit simulator.

LOADOUT TERMINAL

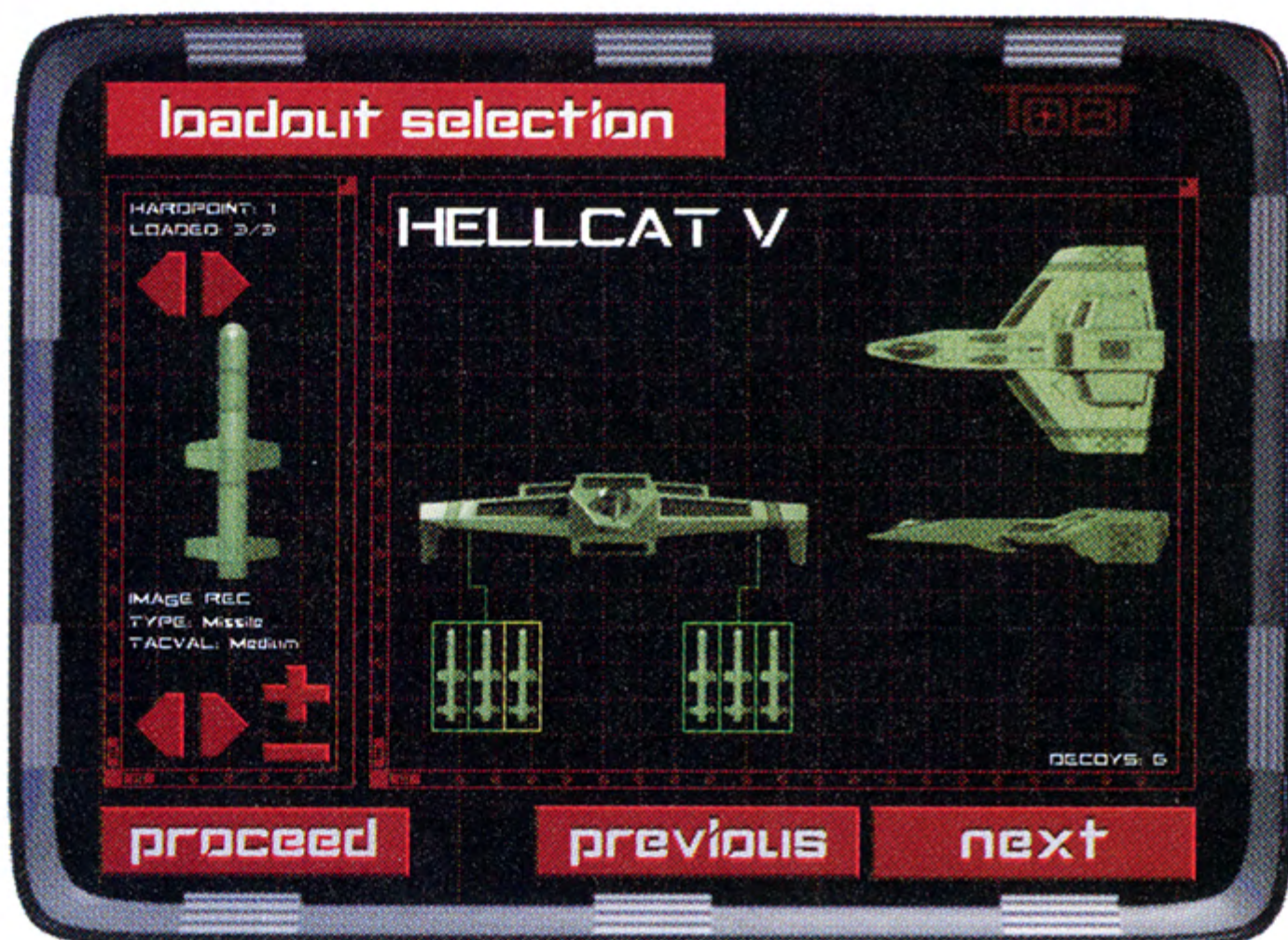

Rachel will select weapons for your first mission. Later, you can pick ships and specify weapon loadouts by activating the Loadout Terminal in Flight Control. To click buttons, move the cursor over the button and press **X**.

PREVIOUS, NEXT Cycle through ship types and specs.

PROCEED Close terminal screen and load ship.

Select the missile rack or top arrows to switch hardpoints (hardpoints are slots for missiles). The number of hardpoints varies between ships. The missile slots available on each hardpoint are indicated by text — “loaded: 1/2” means 1 of 2 hardpoint slots is occupied. Light hardpoints can only carry Heat-Seeking and Dumbfire missiles; heavy hardpoints can carry anything (including mines). Some ships have locked hardpoints (outlined in red) that cannot be changed.

Choose the bottom arrows to cycle through missile types and mines.

+ or **-** adds or removes one missile of the selected type at the current hardpoint.

MISSION BRIEFING ROOM

Prior to each mission, you attend a mission briefing. You'll be briefed by your superiors about the flight path and mission objectives. Then, you'll brief your squadron and pick a wingman by moving the cursor over the person and pressing \otimes . Those available change with each mission, and you must talk to someone before he or she can be selected.

IN THE COCKPIT

When you enter a mission, your ship is in the launch bay. You'll see space directly ahead of you through the front viewscreen of the cockpit and an instrument panel in front of you. All five fighters you fly feature the same instruments, even though gauge positions and screens vary between ships.

To pause spaceflight, open the Option screen by pressing \blacktriangle **START**. Press again to resume flight.

COCKPIT INSTRUMENTS

Arrow Cockpit

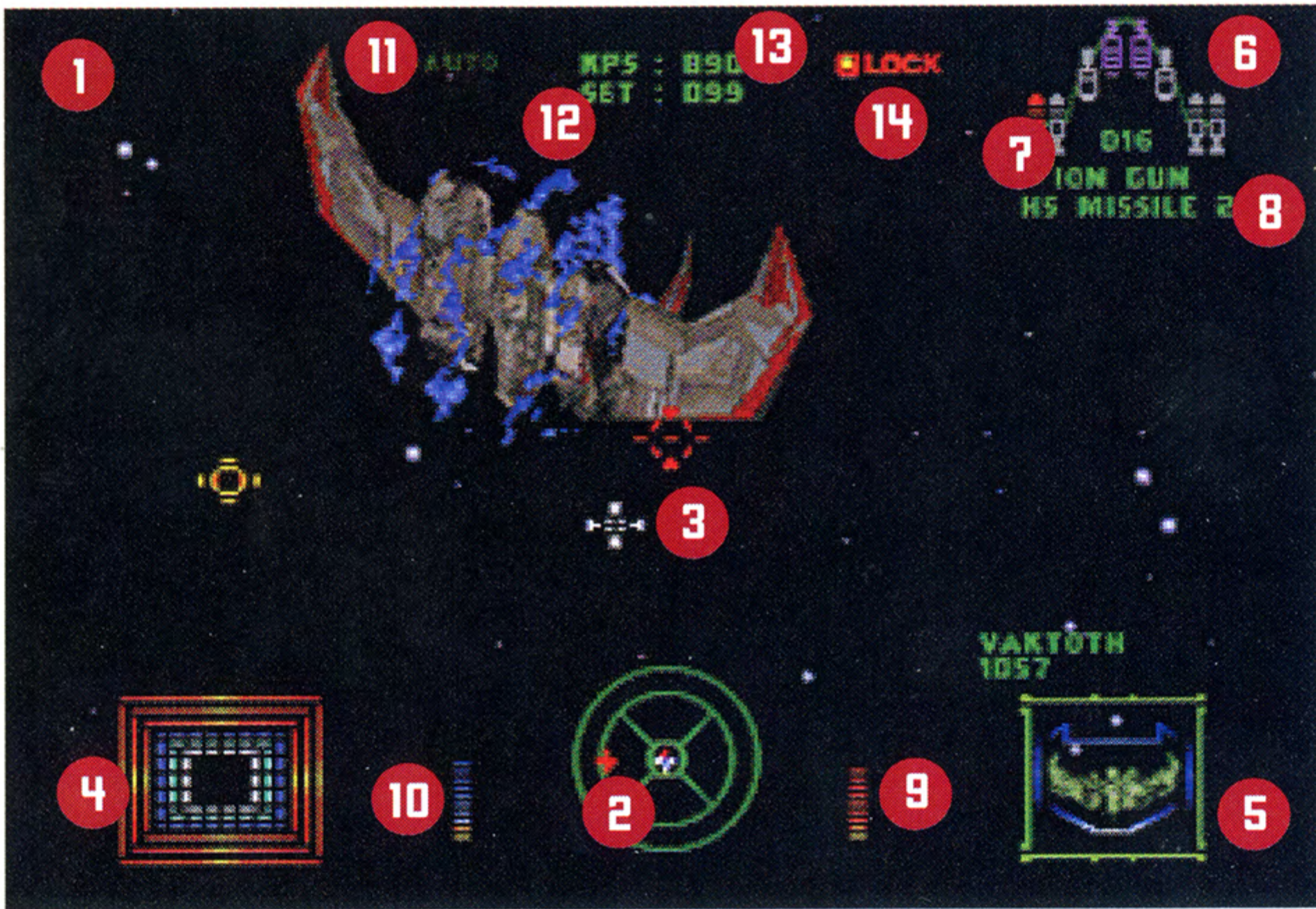

- | | | |
|------------------|------------------------|------------------------|
| 1. Viewscreens | 6. Weapon VDU | 10. Fuel Indicator |
| 2. Radar Display | 7. Active Gun(s) | 11. Autopilot Light |
| 3. Gunsight | 8. Active Missile | 12. Set Speed |
| 4. Left VDU | 9. Gun Power Indicator | 13. Current Speed |
| 5. Right VDU | | 14. Missile Lock Light |

1. VIEWSCREEN

The front viewscreen provides a clear view directly ahead of you, with a virtual cockpit displayed at all times. The red cross hairs in the middle of the screen are your gunsight (3) and show where your ship's guns are aimed. Yellow cross hairs appear on the screen when your locked target is not in front of you. To bring the enemy into view, steer toward the yellow cross hairs — they indicate the targeted ship's position.

When other ships come in view, your computer automatically targets the closest. Red brackets appear around a targeted enemy ship, and a friendly targeted ship gets blue brackets. Green brackets appear around all airborne missiles. Yellow brackets appear around turrets on targeted capital ships.

A profile of the bracketed ship appears in the monitor on the right side of the cockpit (the Right VDU [5]) as long as the ship remains in view. If you lock onto the target (press **L1** **△**), the profile remains in the Right VDU until you destroy the ship or release the lock. Press **L1** **⊗** to switch targets.

Rear camera view. Pressing **SELECT** **R2** shows the view out of the back of your ship. On the Longbow and Thunderbolt, you can use normal gun controls to fire the tailgun while in this view. (The ship remains on course.)

Chase camera view. Pressing **SELECT** **R2** again displays a chase plane view from behind your ship.

External object view. Pressing **SELECT** **R2** again gives you an external view of your ship. Use **L1** **⊕** to pan around the ship. To return to the virtual cockpit view, press **SELECT** **R2** once more.

2. RADAR DISPLAY

The radar display is divided into six sections, and each ship detected appears as a colored dot. The outer ring shows the position of ships behind you; the center circle shows ships ahead of you; and the four middle quadrants represent ship positions alongside, above or below you.

Dots are color-coded, and your current target appears as a cross of the appropriate color.

- | | | | |
|---|--------------------|---|------------------------------|
| ● | Enemy fighter | ● | Friendly capital ship |
| ● | Friendly fighter | ● | Missile (friendly or enemy) |
| ● | Enemy capital ship | ⊕ | Currently selected nav point |

Tactical Tip: To bring an enemy target into view, find a red or orange dot on the radar. Then, maneuver your ship and center the dot in the innermost circle of your radar display. This brings the target directly in front of you and into view.

TOP VIEW



SIDE VIEW



3. GUNSIGHT

For information on the Gunsight, see **Viewscreen (1)**.

4. LEFT VDU



The Left Video Display Unit (VDU) displays one of four different screens:

- | | |
|----------------------|-----------------------|
| a) Shields and armor | c) Damage |
| b) Communications | d) Power distribution |













Press  ,  to cycle through the screens in the Left VDU.

- a. **Shields and Armor.** Shields are designated by an outer set of colored bars in the Left VDU, and armor is represented by a set of inner bars. As you take damage, your shields weaken and the affected bar grows thinner. If your shield generator isn't damaged, shields will regenerate slowly. Once shields are pierced, however, armor starts taking damage and the inner brackets grow thin and disappear. Unlike shields, armor cannot regenerate.

- b. Communications.** You can communicate during flight with any ship within range — taunting an enemy, sending instructions to your wingman or requesting permission to land.

Press  ,  until you see the communication screen in the Left VDU. If you can communicate, you'll see a list of potential receivers on the screen. When a pilot communicates with you, a profile of the sender appears in the VDU and text or speech commences.

Follow these steps to send a message:

1.  ,  Display the communication screen in Left VDU.
2.   or  Cycle through receiving ships or pilots.
3.   Accept highlighted receiver or pilot.
4.   or  Cycle through available messages.
5.   Accept highlighted message and send it.

Wingman Orders

During flight, you can send these orders or other messages.

Break and Attack
(also  ) Tells your wingman to break formation and engage enemy ships.

Form on My Wing
Request Status Tells your wingman to return to formation and follow you.
Asks how much damage your wingman's ship has taken.
(This message also works for friendly capital ships.)



Return to Base Tells your wingman to return to the *Victory* immediately.
If the command is obeyed, your wingman is not available for the rest of the mission.

Help Me Out Here Tells your wingman to engage the enemy attacking you.



Attack My Target Tells your wingman to engage the enemy you have currently targeted.

Keep Radio Silence Prevents your wingman from talking to you.

Lift Radio Silence Allows your wingman to talk to you and breaks the "Keep Radio Silence" command.

Enemy Taunt
(also  ) (Enemies only) Insults an enemy fighter when you have one targeted. Taunting sometimes draws enemy ships to you, luring them away from another friendly ship.















Need Clearance (*Victory* and supply depots only) When you complete a mission and return to base, you must request permission to land.

- c. **Damage.** Press  ,  until you see a ship profile in the Left VDU. The color of panels on the ship profile varies as follows:

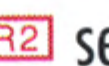
Yellow – System is damaged

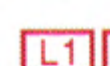
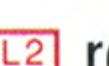
Red – System is destroyed

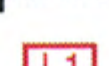
- d. **Power Distribution.** Each ship can store a certain amount of power to operate engines, shields, guns and the damage repair system. You can adjust the amount of power allocated to each of the ship's four power points — Engines, Weapons, Shields and Damage Repair. Distributing more power to one point decreases power allocated to the other three points.

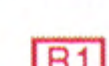
Press  ,  until you see the power distribution screen. Press  ,  to cycle through and select one of the four systems. Pressing    sets the current system's power to 100%, while    resets all power systems to 25% each.   decreases the current system in 5% increments,   increases it in 5% increments. Whenever you decrease (or increase) the allocation to one system, other systems receive more (or less) allotted power.

The more power you allocate to Damage Repair, the faster systems are repaired.

If you set engine power to less than 25%, your maximum speed decreases.



Display/cycle through power systems

 , 

Reset all systems to 25%

Increase current system to 100%, all others to 0%

Reduce current system by 5%

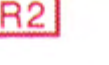
Increase current system by 5%

 

5. RIGHT VDU

When you have a ship targeted, the Right VDU identifies the ship type, its range and its shield strength.

- a. **Target I.D.** When enemy ships come into view, your onboard computer targets the closest ship. You know a ship is targeted when brackets appear around it and a cross appears on your radar (see **Targeting** on p. 19). Red brackets indicate enemy ships, blue brackets denote friendlies. (When Smart Targeting is on, you can only target enemy ships during a battle. See **Smart Targeting**, p.19.)

Text above the Right VDU identifies the ship type and tells how far away it is in clicks.

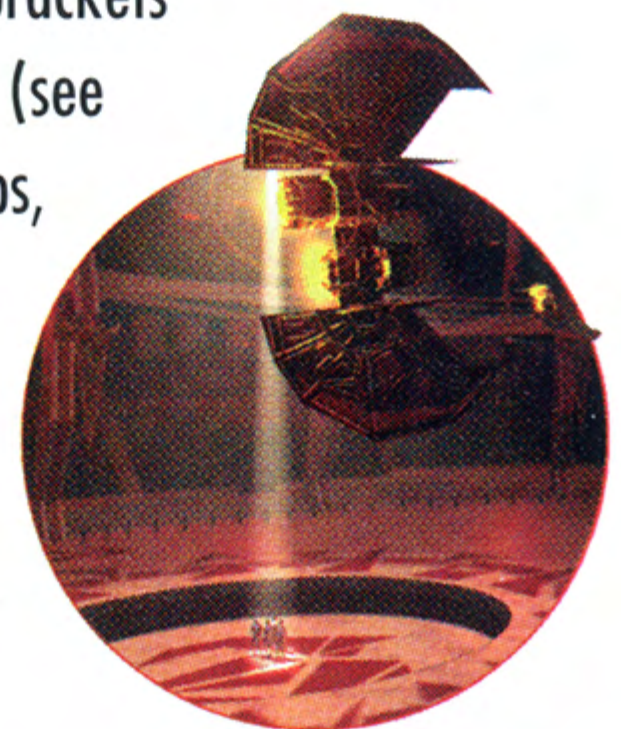

- b. **Target Profile.** Once a ship is identified, its profile appears in the Right VDU. Thin blue lines indicate shield strength. These lines turn red and eventually disappear when you diminish your enemy's shields. When the targeted ship takes armor damage, sections of the profile flash red.





6. WEAPON VDU

Missile and gun icons display in the upper right-hand corner of the cockpit at all times. The active gun(s) and active missile (7 and 8) show up as colored icons, while inactive guns and missiles are gray or grayish-green.



Guns are multi-fire blasters that draw energy from your ship. Missiles are single-shot, self-powered munitions. Different ships have different guns and missiles available.







Note: The Excalibur has an "autotracking" feature. When you have a target in view, your guns automatically aim at that target.

To change the active gun, press **L1** ; to change the active missile, press **L1** . Pressing these keys (**L1**  or **L1** ) multiple times cycles through available guns or missiles. Text in the Weapon VDU changes to reflect the new active gun and missile.

If you're flying a ship with two or more guns, you can prepare all of them at once by pressing **L1** **L2** . Firing all your guns at once quickly runs down gun power.

L1  cycles through missile types.

L1 **L2**  arms all hardpoints and lets you fire all your missiles at once (called a full salvo). See the relevant note in **Missile Lock**, p. 20.

<u>Action</u>	<u>Controller</u>
Change gun	L1 
Change missile type	L1 
Prepare full guns	L1 L2 
Prepare full missile salvo	L1 L2 
Fire active gun(s)	
Fire missile	

7, 8. ACTIVE GUN, ACTIVE MISSILE

For information on these items, see **Weapon VDU** (6).



9. GUN POWER INDICATOR

Tick marks in this gauge indicate the power level of your ship's active guns (location and color vary between cockpits). If you use guns frequently, the power level diminishes and the bar shortens. The more guns you fire at once, the faster you drain gun power. If you have no gun power left, your guns won't fire until some power is regenerated. Guns recover power gradually if your generator isn't too damaged, and the bar grows longer as power is replenished.

10. FUEL INDICATOR

Tick marks in this bar show how much afterburner fuel you have, and they disappear as your tank empties. Using afterburners may help you get out of a dangerous situation or zero in on the enemy, but they burn fuel ferociously. If you run out of fuel, you'll coast on reserves at the ship's maximum cruising speed (which varies between ships).

11. AUTOPILOT LIGHT

The autopilot light (AUTO) is on the instrument panel, although its position varies between ship types. It remains dim if enemy fighters are present, but glows when it is safe to autopilot to the next nav point.



You can autopilot (press **L1** **L2** **R1** **R2**) to the next nav point as long as no enemies or hazards are nearby. If you are able to autopilot, the autopilot light glows. If you try to autopilot when it isn't possible, you'll see "Autopilot not allowed" or "Enemies near."













Autopilot

L1 **L2** **R1** **R2**



12, 13. SPEED INDICATORS

Ships have two numerical speed indicators. Set speed (12) indicates the speed in clicks per second (kps) that your ship tries to maintain on its own (comparable to the cruise control in a car). It changes if you accelerate or decelerate. The current speed (13) shows how fast your ship is moving in clicks per second. It changes when you accelerate or decelerate, turn sharply or use your afterburners.

When you are trying to tail a targeted ship, it's useful to press  . This automatically adjusts your speed to match that of the targeted ship.

<u>Action</u>	<u>Controller</u>
Accelerate	
Decelerate	
Full throttle	  
Cut speed to zero	  
Match speed of target	 
Apply afterburners	 

14. MISSILE LOCK LIGHT

Once an enemy has locked a missile onto your ship, this light glows. (If that missile is in front of you, a green box will appear around it.) When this happens, you can release decoys to distract missiles that are chasing you. (In the Weapon VDU (6), decoys show up as "D," followed by a number.) Once your missile lock light glows, press   to release a decoy, then afterburn away. Note that you have a finite number of decoys (all of which are identical).

Release decoy	 
---------------	--

JUMPING

The *Excalibur* has a jump engine that lets you travel through jump points. This feature will be activated automatically when necessary.

TAKEOFFS AND LANDINGS

You can press **L1 L2 R1 R2** for an automatic takeoff, or take off manually. For a manual launch, press **△** to increase throttle speed. Steer straight ahead to exit the launch bay. When you've cleared the launch bay, press **L1 L2 R1 R2** to autopilot to the first nav point. Before landing, you must obtain permission (described below). Then, you can land automatically by pressing **L1 L2 R1 R2**, or attempt a manual landing.

To obtain permission:

1. Bring the *Victory* into view.
2. Press **SELECT** **◀** or **▶** to display receivers.
3. Use **SELECT** **△** or **▽** to highlight the *Victory*.
4. Press **SELECT** **L1** to accept the *Victory* as the receiver.
5. Press **SELECT** **△** or **▽** to highlight "Need Clearance."
6. Press **SELECT** **L1** to send the message.

To land manually:

1. Maneuver so that your ship faces the launch bay.
2. Slow down below 100 kps and glide into the launch bay.
3. Once you've passed halfway through the hull, you've landed.

Note: If you try to land manually without permission, you can't do anything besides fly through the launch bay.

NAVIGATION

During flight, you have access to a navigational map. To display the map and temporarily pause play, press **SELECT** **L2**. The currently selected navigational point appears as a white sphere. Completed nav points are blue, uncompleted ones are red.

Text in the blue box describes the mission name and nav point objective, and gives notes for the current nav point. Whenever you select a different nav point (by pressing **○** or **◻**), this text changes. Use **⊕** to rotate the map.

Open or close nav map (toggle)

SELECT **L2**

Select next or previous nav point

○ or **◻**

Zoom in and out, respectively

△ and **⊗**



Cycle through targets in area

△



Note: Friendly ships are designated by blue circles, enemy ships by red circles. Your ship is enlarged and red.

TARGETING

Your ship's targeting system automatically targets the closest ship and places red (enemy) or blue (friendly) brackets around it. As long as a ship is targeted, the Right VDU (pp. 14-15) displays a profile of that ship. Text above the Right VDU describes the targeted ship type. You must have a ship targeted before you can fire Heat-Seeking, Image-Recognition, Friend-or-Foe or Leech missiles, or torpedoes.

To cycle through multiple targets in your viewscreen, press   repeatedly. (You can only target one ship at a time.) As you switch targets, the brackets shift to another ship in your viewscreen.

To match the speed of a targeted ship, press  .

When you target a capital ship, your ship places a yellow box around the closest turret gun location (in addition to the red targeting brackets around the ship). Press   to target another turret.

Cycle through visible targets







Match target speed





Cycle through turrets



Target Lock



Once you have a targeted ship in view, "lock" onto it by pressing  . This activates a shot-targeting system (I.T.T.S.) and gains a permanent target lock on a ship. A locked target is framed by a solid box instead of brackets. Once you do this, the lock remains active even if the ship moves out of view. To unlock a ship, press   again.

A locked ship appears as a large cross on the radar. When you have a ship locked,   cycles through all ships (whether they are in view or not) and switches the lock to the new targeted ship.

Lock/unlock targeted ship



Smart Targeting

During battle, it's more efficient to only cycle through enemy targets. If you want to turn off Smart Targeting, press  . This instructs your targeting computer to target both enemy ships and friendly ships.

Disengage/engage Smart Targeting
(on by default)



Inertial Targeting and Tracking System (I.T.T.S.)

All fighters employ the I.T.T.S., a system that calculates how much you must lead your target in order to maximize your chance of a hit. When you lock onto a targeted ship, the I.T.T.S. places diamond-shaped green cross hairs near the targeted ship whenever it's in sight. It takes into account the enemy's current direction and speed and automatically computes the necessary "lead" needed. If you line your gunsight up on the diamond instead of the targeted ship, your shots are more likely to hit the target.

Missile Lock

Depending on what ship you're flying, you have access to certain missiles. Most have their own locking mechanisms. Dumbfire and Friend-or-Foe missiles are an exception. (See pp. 43-45 for specific missile information.)

If you have a missile selected that requires a lock and a targeted ship comes into view, red cross hairs appear outside the targeting brackets. They move toward the center of the brackets. Keep the target in view. Once you move within range for the selected missile type, the red missile-lock cross hairs turn green. When the brackets have closed in on the target, you'll hear a missile lock tone. This means you can fire your HS, IR or Leech missile, or torpedo.

Missiles remain locked until fired or until the targeted ship moves out of view.

If an enemy has fired a missile at your ship, the missile lock light (14) in your cockpit glows. See **Missile Lock Light** (p. 17) to learn how to use decoys.

Note: If you fire a full salvo (press **L1** **L2** **□** to arm all missiles), you'll get a tone when the first missile type has a lock. (Note that the DF and FF can be fired immediately.) Keep in mind, however, that you have to wait long enough for all missile types to lock for all of them to fire. When you fire, only the missile types that have acquired a lock at that point will fire.

CLOAKING

Later in the game, the experimental Excalibur fighter is equipped with a defensive cloaking mechanism that makes it invisible to other ships for a short period of time. To activate cloaking, press **L1** **R2** and hold them for one second. Once you cloak, your ship temporarily disappears from view and from your enemy's radar screen.

When you're cloaked, your view turns to light blue.

Also while cloaked, you cannot fire missiles or normal guns. Any enemy missiles that are already locked onto your ship will remain locked until you're completely cloaked. After you're invisible, enemy missiles cannot initiate or maintain a lock on your ship.

Note: You can cloak only once during the entire game, in one specific mission.

DYING

If you sustain severe damage in flight and die, a plaque displays:

- REPLAY MISSION* Return to the cockpit and take off again with the same ship/loadout.
- FUNERAL* View death scene, then return to saved game screen.



EJECTING

To avoid dying when your ship sustains severe damage, you can eject. Ejecting will emit a rescue signal, and you'll be picked up by a friendly ship (in most cases). Eisen, however, will give you a stern reprimand for wasting your fighter.

Eject

L1 L2 R1 R2  SELECT START

IN-FLIGHT OPTIONS

To access in-flight options, press . This displays a checkbox screen. To activate an option, move the cursor over its box and press .

- GAMEPLAY* Turn in-flight collisions ON/OFF, and/or make your ship invulnerable to damage (when on, you can't die).
- AUDIO* Turn music, speech, soundfx, and capital ship rumble ON/OFF during spaceflight. Note: soundfx has to be on in order for you to hear rumble.
- SKILL LEVEL* Adjust the enemy skill level. Choose between ROOKIE, VETERAN, ACE, HARD, CRAZY or NIGHTMARE.
- ARCADE* Reverses up/down on keypad controller.
- DEFAULT* Reset all options to their default settings.
- EXIT* Exit the Option screen and resume spaceflight.



MAIN TERMINAL OPTIONS

Main Terminals in the Gunnery, Bridge, Berth and Flight Control areas let you save and load games, as well as adjust music and sound. For screens with toggle boxes, bright boxes indicate an active option, dark boxes indicate an inactive option.

<i>DUTY LOGS</i>	Save/load games (see p. 4). Note: make sure you have inserted a memory card before you try to save/load a game.
<i>CONTROLS</i>	Adjust music and sound. (Changes are included in saved games.)
<i>NEWS</i>	Lets you view newscasts (plays new ones when they're available).
<i>LOGOFF</i>	Return to the normal game screen.

Sound

<i>MUSIC</i>	Toggle music ON/OFF.
<i>SOUND FX</i>	Toggle sound effects ON/OFF.
<i>MUSIC VOLUME</i>	Increase/decrease music volume. Click the arrows to adjust volume from 1 (low) to 10 (high).
<i>SOUND VOLUME</i>	Increase/decrease sound volume. Click the arrows to adjust volume from 1 (low) to 10 (high).

Miscellaneous

<i>TRANSITIONS</i>	Toggle transitions between scenes, such as the elevator, ON/OFF. Default is OFF.
<i>STARS</i>	Toggle star animations in windows ON/OFF.
<i>DESCRIPTIONS</i>	Toggle text prompts ON/OFF.



TRANSFER INFORMATION

Electronic Creative Services welcomes you to your new assignment aboard the TCS *Victory*. It is our sincere hope that you enjoy your personalized Shipboard Orientation Kit.

All entries are compiled from newsgroup articles and GIFs (General Information Files) from the Shipboard Information Datanet (S.I.D.).

INTELL REPORT: KILRATHI ACES

>tcn.victory.intell

Posted 2669.218

A number of Kilrathi aces have been identified in sectors assigned to the TCS *Victory*. I suggest you employ extreme caution when engaging any of these known enemies, all of which exhibit dangerous dogfighting combat skills.

Najji "Fireclaw" Ragitagha

Preferred craft: Darket light fighter

Although Fireclaw is not a pilot to be taken lightly, the relative lack of weapons and shields in his fighter of choice might render him vulnerable to coordinated attacks. He usually retreats when outnumbered or obviously outgunned.

Marjakh "Stalker" nar Kur'u'tak

Preferred craft: Strakha stealth fighter

Keep your eyes open for Stalker. He won't announce his presence in advance. The first time you'll know he's there is usually when he opens fire. Little is known about Kilrathi stealth technology, but it's believed that the Strakha possesses inferior armor. The challenge, of course, is drawing a bead on the fighter in the first place.

Prince Thrakhath

Preferred craft: Bloodfang heavy fighter

Even though Prince Thrakhath rarely flies anymore, when he does he invariably means business. Thrakhath's skills as a pilot are legendary and will require every ounce of your skill and energy to thwart. His ship of choice is the Bloodfang, which is said to be pound-for-pound a match for our own new Excalibur-class fighter.

Note: Intell has logged three isolated reports of a new Kilrathi rock fighter which appears to lurk in asteroid fields and spring on craft from in this dangerous environment. If you or any of your pilots encounter one of these rumored fighters, submit a full written report to HQ for inclusion in the ongoing intelligence profile that is being assembled.

PILOTS OF THE MONTH

>tcn.victory.flight.pilots

Compiled 2669.220

Electronic Creative Services extracted "Pilot of the Month" articles for the last five months prior to your arrival as the *Victory's* Wing Commander. All pilots selected by Quantum are exemplary crew members with active combat status. You will find combat biographies for each pilot listed under tcn.victory.flight.pilots.bios. Each pilot's significant contribution is given in the following section, along with a short biography file.

LIEUTENANT LAUREL BUCKLEY

Age: 32

Award Date: 2669.090

Homeworld: Enyo

Callsign: Cobra

Leisure activities: Martial Arts

Determining Factor: Escorted three supply runs to and from Hampton station in the Orsini system and successfully defended transport ships from four Kilrathi attacks.



Excerpt from Self-Analysis: I know that a lot of people weren't exactly thrilled when I was assigned to the *Victory*. After all, I'm the only pilot here who hasn't gone through Academy, and people didn't know how far they could trust me as a wingman. I was a wildcard with a hard attitude. Truth is, I didn't have enough time to go through the Academy. The cats ate my past up, and left me nothing but cold blood and anger. Every day I wasn't gunning after those monsters was another day of my life wasted. It was Commander Eisen who gave me my callsign after seeing my style on my first mission. Quick and deadly is the way to treat these cats. Working on the *Victory* has been the single proudest thing I've ever done. This is my home.

Most often heard quote: "I won't rest till the last cat is history."

LIEUTENANT WINSTON CHANG

Age: 38

Award Date: 2669.120

Homeworld: Enigma Sector

Callsign: Vagabond

Leisure activities: Fine-tuning my winning streak at cards

Determining Factor: Acted as a decoy ship during an ambush on a small Kilrathi fleet, allowing Longbow bombers to eliminate two destroyers, one corvette and a light carrier.

Excerpt from Self-Analysis: When you've seen as much as I have, you develop a sharp appreciation for quality. This ship is filled with fine people, as well as skilled pilots. If I had a complaint, it would be that my crewmates play cards like a ship full of grandmothers.

Most often heard quote: "Take your mind off your troubles with a quick hand?"



LIEUTENANT MITCHELL LOPEZ

Age: 27

Award Date: 2669.151

Homeworld: Dakota

Callsign: Vaquero

Leisure activities: Music

Determining Factor: Risked life to retrieve two ejected pilots during a single mission.

Excerpt from Self-Analysis: Sometimes I try to write music to capture the feel of the *Victory*, but I can't. My hands aren't good enough to bring it out of the guitar. But it's there. That's why I like the lounge. I can see the people, and hear their parts. In my mind, I can hear many different chords creating harmony. It is deep, an ocean of sound and feeling that I almost can't explain.

Most often heard quote: "I'll have that in my cantina, too."

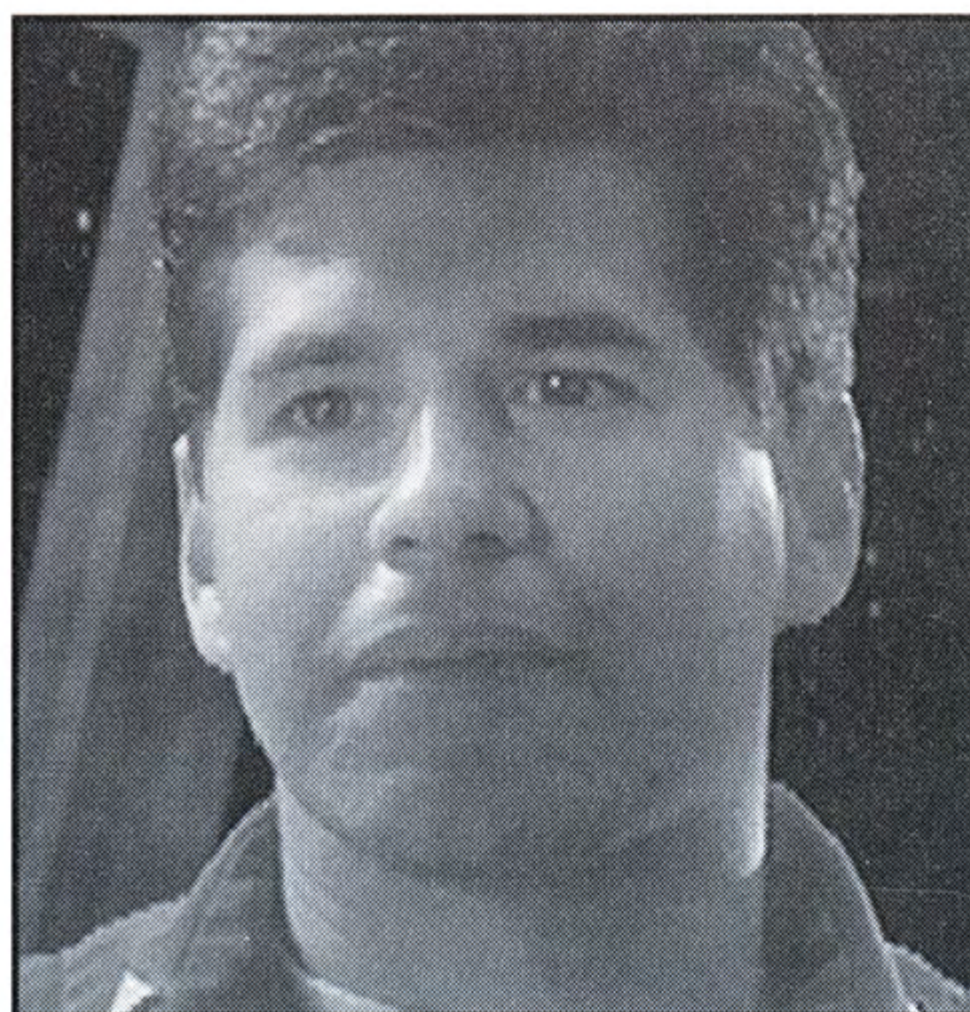

MAJOR TODD MARSHALL

Age: 32

Award Date: 2669.181

Homeworld: Leto

Callsign: Maniac

Leisure activities: Avoiding interviews

Determining Factor: Single-handedly attacked an enemy scout squadron and destroyed all five fighters present, defending the *Victory's* tactical position and preventing transmission of the scout group's findings.

Excerpt from Self-Analysis: Listen, the first thing to remember is that you have to grab the glory right from the cat's mouth if you're ever going to get anywhere. Think of this as advice from an old-time flyboy. I've been the best from the first time I went star-sledding. You have to do more than zig when they're looking for you to zag. It's not just the way to fly, it's the only way to live.

Most often heard quote: "Did I tell you about the time I ...?"



LIEUTENANT ROBIN PETERS

Age: 32

Award Date: 2669.212

Homeworld: Locanda

Callsign: Flint

Leisure activities: Flight simulator

Determining Factor: Destroyed 3 Kilrathi fighters in 2 days, despite the loss of her wingman during 2 sorties.



Excerpt from Self-Analysis: We have to remember that this is more than just a tour of duty. The planets we're protecting wouldn't have a chance without us. It's not easy ... there isn't a person on board who hasn't lost someone to the enemy. We all carry scars on our souls. My only suggestion is to gather up all the hurt and loss, and forge the strength to do whatever is necessary to win. We will win. We must.

Most often heard quote: "If in doubt, don't. It's probably not in the regs."

THE SECRET OF THE EXCALIBUR

>tcn.victory.news

Posted 2669.214

Interview by 2nd Lt. Angela Engleman

Transcription by Lt. Lawrence Raltson

1st Lieutenant Jace Dillon, better known as "Flash," is a Security II test pilot with the Research & Development base in Vega Sector. Recently, he's concentrated his efforts on perfecting the raw edges of the new heavy fighter, the Excalibur. When we contacted TCN R&D Operations, they granted a Holo-Link interview with Lt. Dillon, who provided a few tantalizing morsels about the Terran Navy's latest vehicle of war.

1st Lieutenant Jace Dillon

Callsign: Flash

Occupation: Test pilot

Age: 25

Station: TCN R&D, Vega Sector

Victory Tell me, Jace. What's all the hype about this new Excalibur fighter?

Flash Well, that's classified info. But, I happen to know this puppy like the inside of my flight suit. She's a hell of a step above our other ships.

Victory How do you think the Excalibur is going to complement our existing attack fighters?

Flash The main advantage is that it can outfly everything — with the right person behind the controls, of course. It'll outrun an Arrow, and it's even got heftier shields than most of the Kilrathi's top-of-the-line fighters.

Victory What kind of numbers can you give us?

Flash I can't disclose that information, of course. Let's just say she could hypothetically cruise at a cool 500 kilometers per second, and could afterburn around 1300 k/s². One stat that's in the public domain is her solid shield rating — 250, to be exact.

Victory With those kind of stats, why aren't we replacing all of our fleet fighters with it?

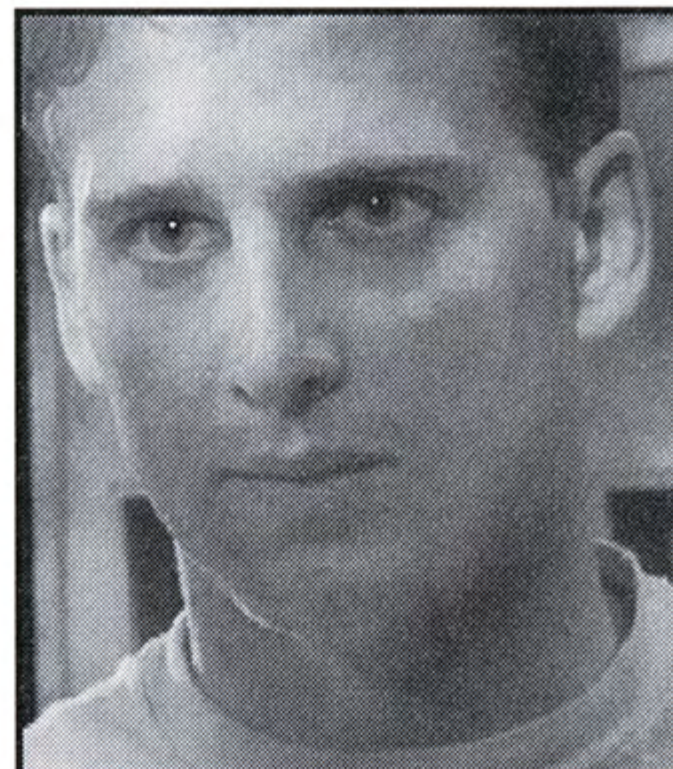

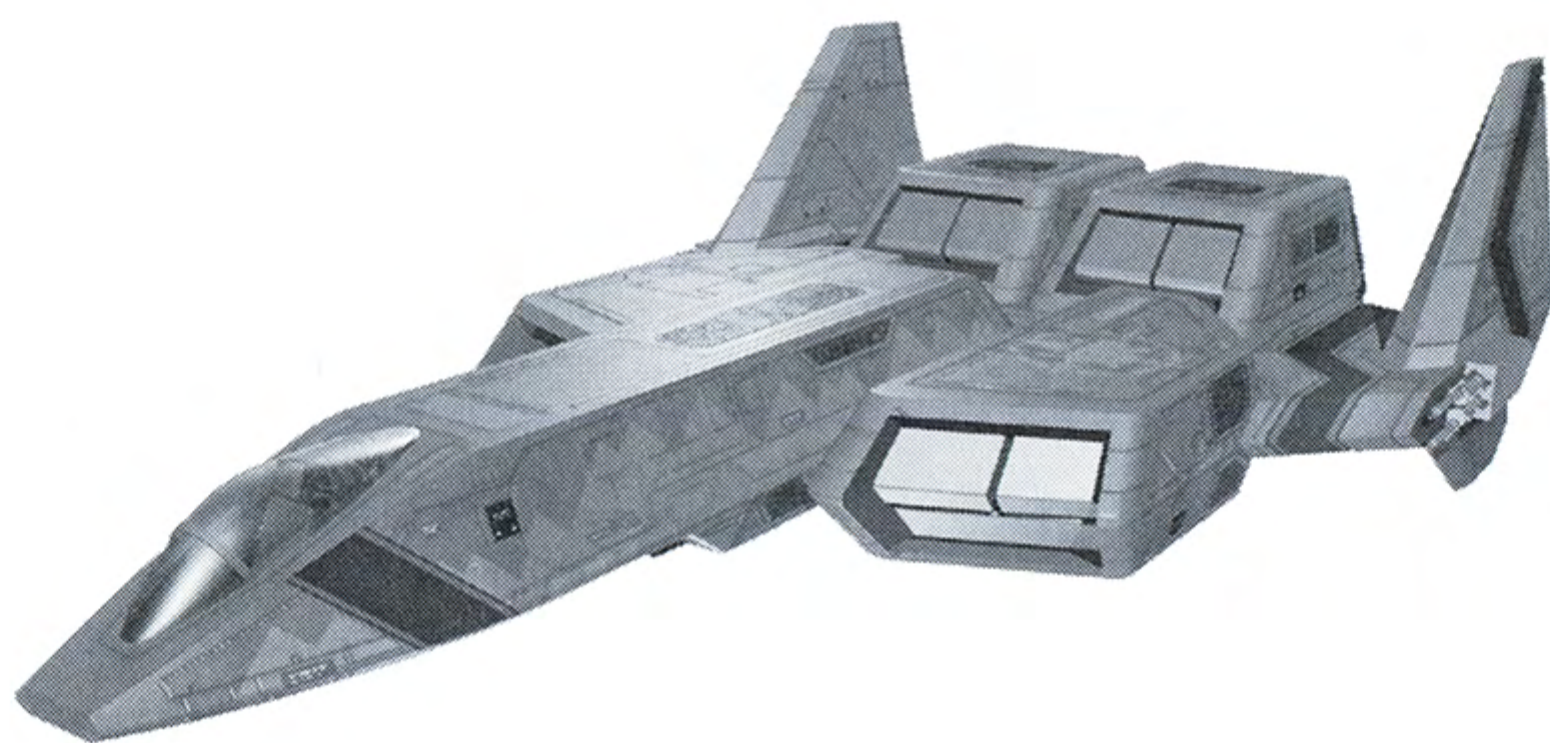

Flash You know how long it takes to get something like this going? If you don't have pull, you're looking at another year of development, at least.

Victory Once we do get it, what kind of attack will the Excalibur be best suited for?

Flash That's the beauty of this vehicle. I've tested its bombing capabilities in orbits over the sands of Kentari, flown recon above the heavy atmosphere of Jupiter, and tested the firepower in a few simulated fleet attack missions.

Victory So what's the verdict?

Flash Handles like a charm. I'm convinced it'll run any mission we can take it on, especially in heavy combat situations.

Victory Sounds like an incredible breakthrough. But, do you foresee any major drawbacks?

Flash Only a minor one — armor strength. I probably shouldn't be telling you this, but I've had it up to here trying to persuade those hard-headed aeronautics engineers to flank it with more dura-steel. But they're imbeciles and never listen to my suggestions ... even after I nearly killed myself when another ship clipped my wing in formation. You'd almost think they planned it that way.

Victory Dangerous work, huh? Being a test pilot must be stressful.

Flash No kidding! It's a good thing I've got nerves of steel. Pretty necessary for a pilot who's got to live day-by-day.

Victory Don't you miss being where the action is — on the front lines?

Flash Not quite. I'm not going to do the Confederation's war effort much good if I'm dead, now am I?

GIF: SHIP STATISTICS

>tcn.victory.flight.shipstat

These fighter and capital ship statistics reflect the capabilities of ships available on the *Victory*. The shipstat.lst file also contains vital statistics for the fleet's capital ships.

Default fighter weapons specified by Chief Tech Rachel Coriolis are given here. However, you have clearance to download customized ordnance using the Loadout Terminal on the Flight Deck.

STATISTICAL DEFINITIONS

Class. The class of ship (light fighter, bomber, etc.).

Length. The ship's length in meters.

Mass. The physical tonnage of each fighter and bomber (in metric tonnes).

Maximum YPR (Yaw, Pitch, and Roll). The maximums for each characteristic (in degrees per second, or dps).

Yaw. Ability of a ship to turn right or left without changing its vertical position.

Pitch. Ability to change direction up or down.

Roll. Ability of a ship to rotate along an imaginary axis extending through the nose and tail.

Max. Velocity/Max. Afterburn Velocity. Velocity settings that are governed by the ship's computer and set in relation to (a) the flagship, (b) an escorted vessel, (c) a nearby planetary body, (d) a beacon or (e) a value derived from radar positions of all visible ships. The velocity is expressed in kilometers per second (kps).

Acceleration. The evaluation of the ship's acceleration rate, without afterburners, given in kilometers per second squared (k/s²). Ships can accelerate and decelerate at the same rate.

Weapons. Every ship has a different array of guns and weapons. Numbers in parentheses indicate how many guns/weapons of that type are loaded. For missile and torpedoes, the number of hardpoints is given, along with the maximum number of missiles per hardpoint. Ships may have both light ("L") or heavy hardpoints ("H"). As an example, 2 x 2L, 2 x 2H indicates two light hardpoints with two missiles each, and two heavy hardpoints with two missiles apiece. Light hardpoints carry HS and DF missiles, while heavy ones carry any type of missile or mine. The default missile loadouts are shown for each hardpoint as 2 HS / 2 HS, etc., with each type corresponding to a single hardpoint.

Shields. The shield strength for each ship is measured in centimeters equivalent to durasteel. Shields regenerate, as long as the generator has not been destroyed.

Armor. Defensive armor is measured in centimeters thickness of durasteel.

Vulnerability Note: Every capital ship and orbiting base has specific points that must be defended: engines, bridges, etc. During Fleet Defense missions, concentrate on keeping enemy fire away from these vulnerable areas. In Raid missions, try aiming for these weak points on capital ships.

CONFEDERATION FIGHTERS

Arrow

This light, versatile fighter has balanced weaponry and is best-suited for short-range combat against light or heavy fighters. Its maneuverability makes it a prime choice for escort, fleet defense and reconnaissance missions, and an emergency life-support system can sustain pilots for up to 7 hours.

Class	Light Fighter	Armor	Fore/Aft	80 cm
Length	20 meters		Right/Left.....	60 cm
Mass.....	13 metric tonnes	Weapons	Laser (2)	
Max. YPR.....	80/90/90 dps		Ion cannon (2)	
Max. Velocity	520 kps		Missile hardpoints (4 x 2L)	
Max. Afterburn Velocity	1400 kps		2 HS / 2 HS / 2 IR / 2 IR	
Acceleration	250 k/s ²		Missile decoys (16)	
Shields	200 cm equiv.	Jump Capable	No	

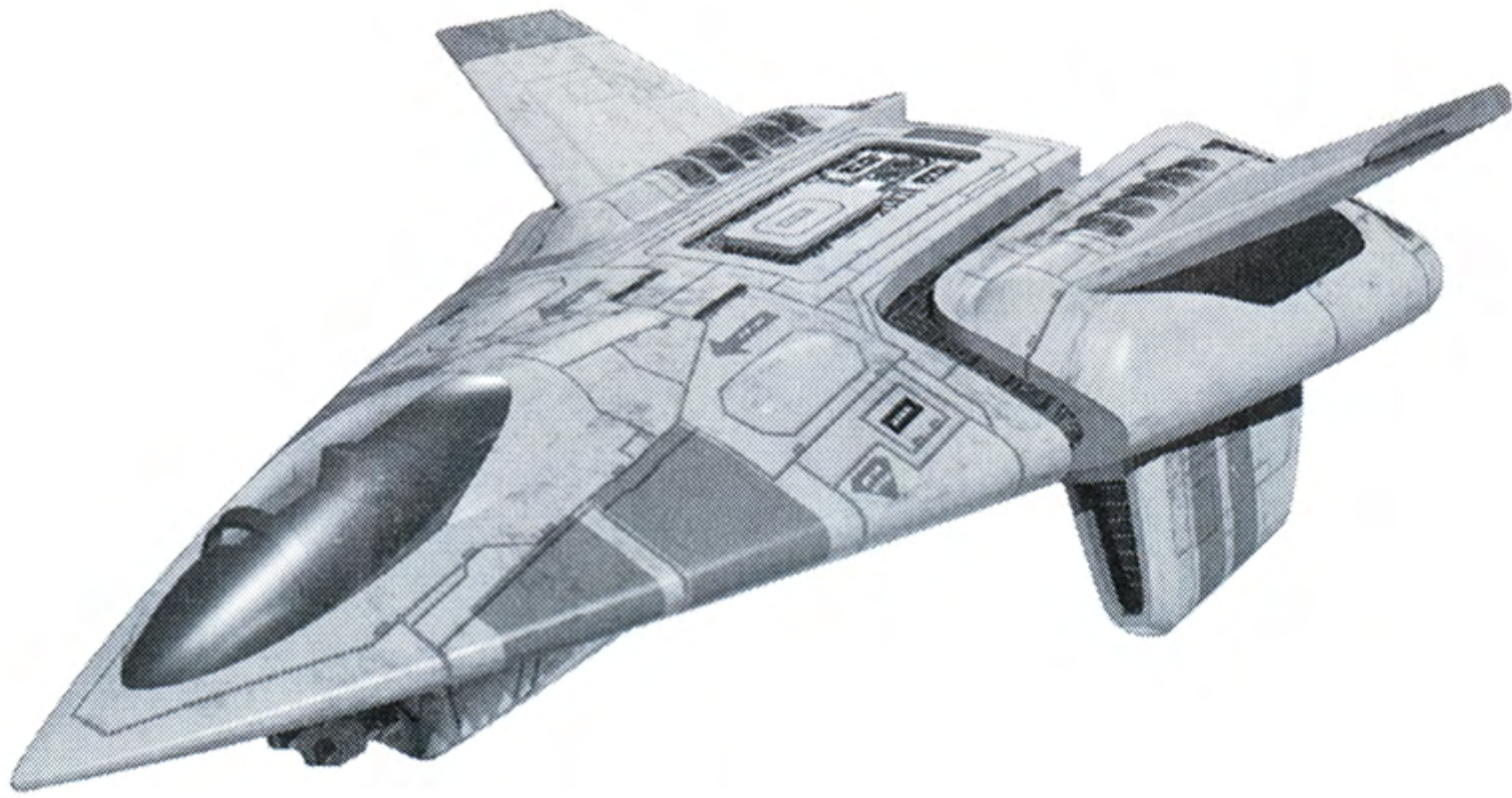

Hellcat V

The baseline Terran fighter, the Hellcat V is a solid vehicle in any combat situation. Most are deployed in attacks against smaller fleet ships

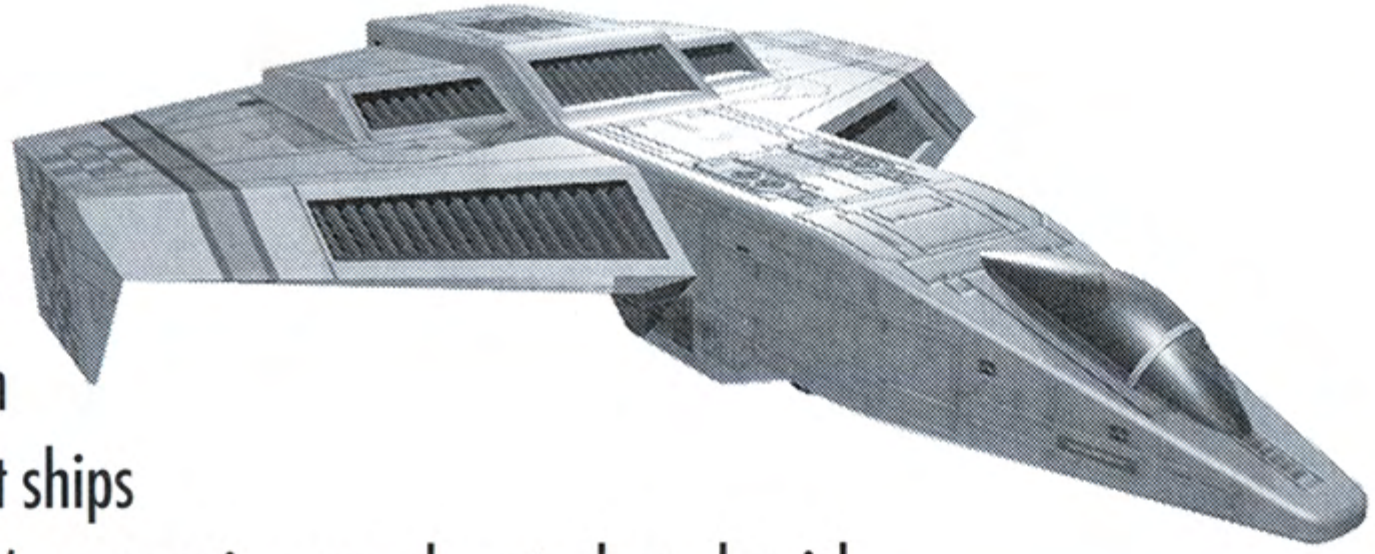

or serve as escorts. The ship's responsive speed controls and quick turn radius make the latest Hellcat the best all-around ship in the fleet.

Class.....	Medium Fighter	Armor	Fore/Aft	100 cm
Length	27 meters		Right/Left.....	80 cm
Mass.....	14 metric tonnes	Weapons	Neutron gun (2)	
Max. YPR.....	60 dps		Ion cannon (2)	
Max. Velocity	420 kps		Missile hardpoints (2 x 3H)	
Max. Afterburn Velocity	1200 kps		3 IR / 3 IR	
Acceleration	225 k/s ²		Missile decoys (24)	
Shields	220 cm equiv.	Jump Capable	No	

Thunderbolt VII

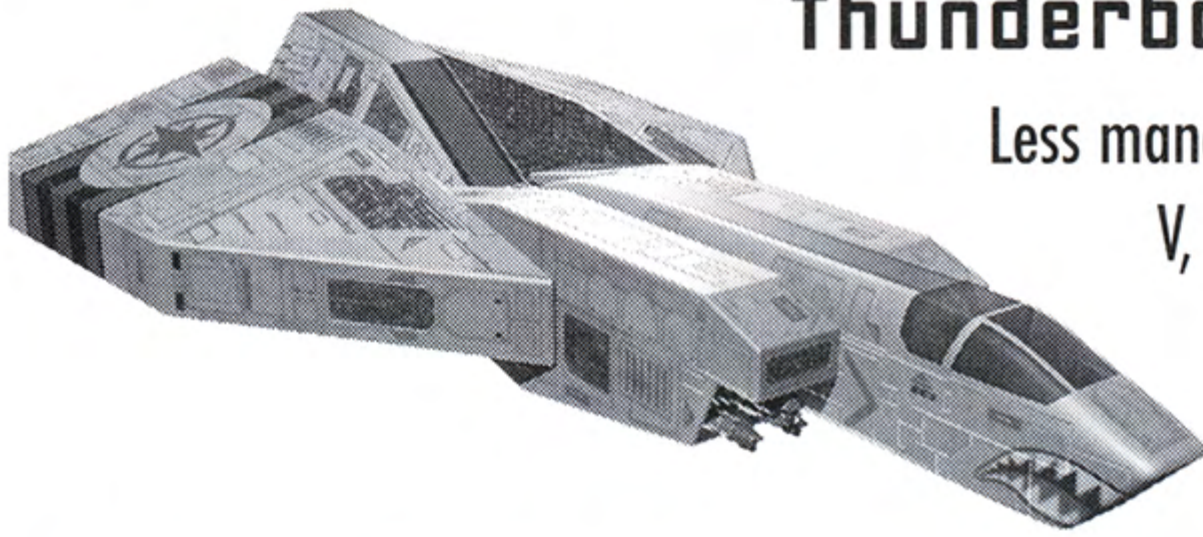

Less maneuverable than the Arrow or Hellcat V, the Thunderbolt VII has a formidable set of guns and missiles. It has a remarkable success rate against light capital ships and

medium-to-heavy fighters, though light fighters tend to outrun its fire. Most pilots agree that the Thunderbolt can satisfy most mission requirements outside of scout missions.

Class	Heavy Fighter	Weapons	Photon gun (2)
Length	34 meters		Plasma gun (2)
Mass.....	20 metric tonnes		Meson blaster (2)
Max. YPR.....	50 dps		Laser rear (1)
Max. Velocity	380 kps		Missile hardpoints (2 x 3)
Max. Afterburn Velocity	1000 kps		3 HS / 3 HS
Acceleration	200 k/s ²		1 Torpedo
Shields	250 cm equiv.		Missile decoys (24)
Armor	Fore/Aft:	Jump Capable	No
	Right/Left:		
	160 cm		
	160 cm		

Longbow

The Longbow bomber has a single purpose — to deliver torpedoes to enemy capital ships. Its lack of maneuverability attracts light enemy fighters like hornets. The Longbow's massive firepower bolsters any offensive force involving capital ships, as long as light fighters are along for protection.

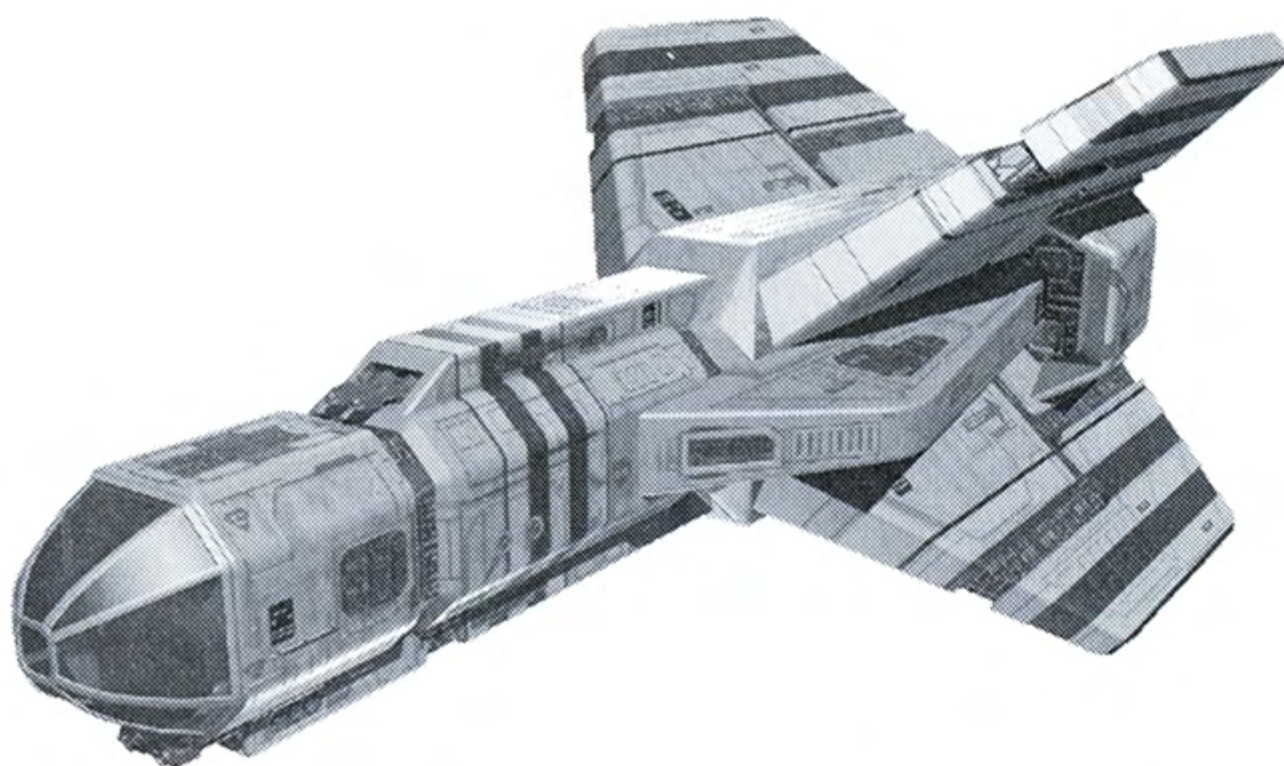

Class	Torpedo Bomber	Weapons.....	Plasma gun (2)
Length	38 meters		Neutron gun (2)
Mass.....	22 metric tonnes		Laser rear (1)
Max. YPR.....	30/40/30 dps		Missile hardpoints (4 x 4)
Max. Velocity	320 kps		4 HS / 4 HS / 4 mines / 4 mines
Max. Afterburn Velocity	700 kps		Torpedos (2 x 2)
Acceleration	125 k/s ²		Missile decoys (24)
Shields	500 cm equiv.	Jump Capable	No
Armor	Fore/Aft:		
	Right/Left:		
	300 cm		
	300 cm		

CONFEDERATION CAPITAL SHIPS

Supply Depot

Length	1425 meters	Acceleration	0 k/s ²
Mass	585,000 metric tonnes	Shields	0
Max. YPR.....	0 dps	Armor	Fore/Aft
Max. Velocity	0 kps		10,000 cm
			Right/Left
			10,000 cm
		Weapons	None

Starbase

Length2500 meters
Mass650,000 metric tonnes
Max. YPR.....5 dps
Max. Velocity150 kps
Acceleration10 k/s²
Shields4000 cm equiv.
Armor Fore/Aft1000 cm
 Right/Left.....1000 cm
WeaponsNone

Cruiser

Length530 meters
Mass18,200 metric tonnes
Max. YPR.....5 dps
Max. Velocity150 kps
Acceleration10 k/s²
Shields3000 cm equiv.
Armor Fore/Aft1000 cm
 Right/Left.....1000 cm
Weapons.....Laser turret (12)

Frigate

Length620 meters
Mass28,000 metric tonnes
Max. YPR.....5 dps
Max. Velocity180 kps
Acceleration10 k/s²
Shields1000 cm equiv.
Armor Fore/Aft600 cm
 Right/Left.....600 cm
Weapons.....Laser turret (3)
 Missile tube (2 FF)

Destroyer

Length490 meters
Mass19,000 metric tonnes
Max. YPR.....5 dps
Max. Velocity200 kps
Acceleration10 k/s²
Shields2000 cm equiv.
Armor Fore/Aft1000 cm
 Right/Left.....1000 cm
Weapons.....Laser turret (9)

Transport

Length160 meters
Mass.....2300 metric tonnes
Max. YPR.....5 dps
Max. Velocity100 kps
Acceleration10 k/s²
Shields2000 cm equiv.
Armor Fore/Aft300 cm
 Right/Left.....300 cm
Weapons.....Laser turret (2)

Light Carrier

Length720 meters
Mass28,000 metric tonnes
Max. YPR.....5 dps
Max. Velocity120 kps
Acceleration10 k/s²
Shields3000 cm equiv.
Armor Fore/Aft1000 cm
 Right/Left.....1000 cm
Weapons.....Laser turret (11)

GIF: Kilrathi Ship Statistics

>tcn.victory.intell

Subject to change, these enemy fighter and capital ship statistics are updated monthly. If you have not overwritten your personal copy by the sixth day of the month, this enemystat.lst file will automatically download into your personal databank.

KILRATHI FIGHTERS

Darket

The Darket is a light fighter with an incredibly fast turn rate. Its light armor and shielding are counter-balanced by its speed and acceleration, making it difficult to track during battle.

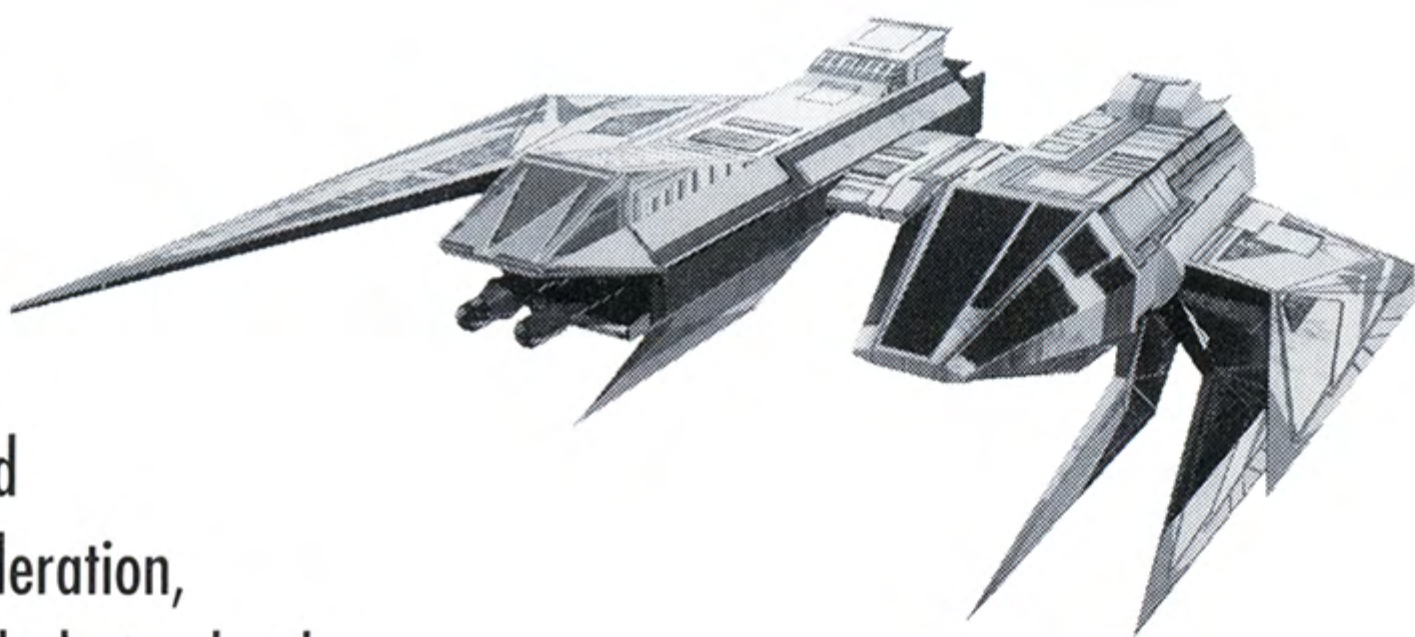

Class	Light Fighter	Armor	Fore/Aft:	60 cm
Length	24 meters		Right/Left:	40 cm
Mass	12 metric tonnes	Weapons	Meson blaster (2)	
Max. YPR	90/80/90 dps		Missile hardpoints (1 x 2)	
Max. Velocity	520 kps		2 HS	
Max. Afterburn Velocity	1350 kps		Missile decoys (6)	
Acceleration	250 k/s ²	Jump Capable	No	
Shields	80 cm equiv.			

Vaktoth

The Vaktoth is a heavy Kilrathi fighter whose performance is slightly better than that of the Confederation Thunderbolt. With its jump capabilities and auxiliary meson guns, this fighter is primarily used for escort and scout missions that do not involve capital ships.

Dralthi IV

Having endured decades of revision, the fourth generation of the Dralthi medium fighter is comparable to the Thunderbolt. It's slightly faster and more maneuverable, but has mediocre shielding and armor.



Class.....	Medium Fighter	Armor	Fore/Aft:	80 cm
Length	31 meters		Right/Left:	60 cm
Mass.....	15 metric tonnes	Weapons	Particle cannon (1)	
Max. YPR.....	55/65/55 dps		Meson blaster (2)	
Max. Velocity	430 kps		Missile hardpoints (1 x 4)	
Max. Afterburn Velocity	1100 kps		4 IR	
Acceleration	200 k/s ²		Missile decoys (6)	
Shields	120 cm equiv.	Jump Capable	No	

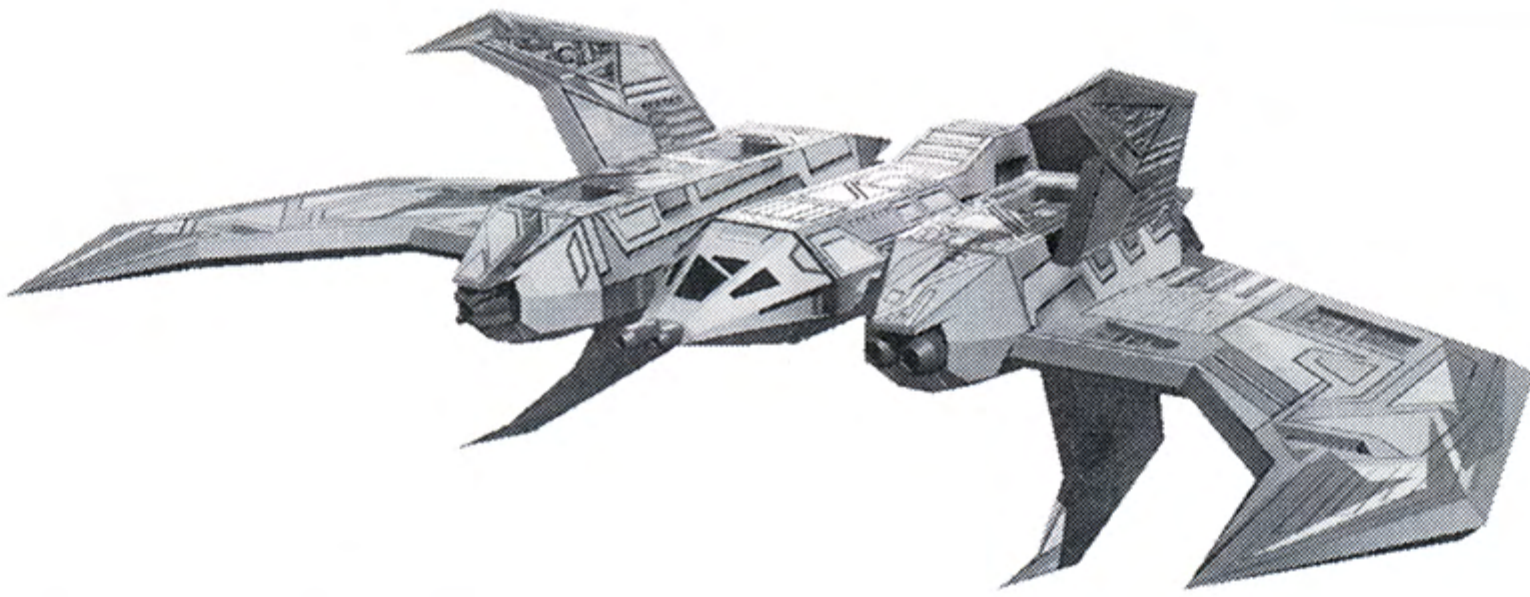

Vaktoth Statistics

Class	Heavy Fighter	Shields	260 cm equiv.
Length	36 meters	Weapons	Tachyon gun (1)
Mass.....	19 metric tonnes		Plasma gun (2)
Max. YPR.....	50/60/50 dps		Ion cannon (2)
Max. Velocity	410 kps		Meson gun rear (1)
Max. Afterburn Velocity	1100 kps		Missile hardpoints (2 x 4)
Acceleration	150 k/s ²		4 HS / 4 HS
Armor	Fore/Aft:		Missile decoys (8)
	Right/Left:	Jump Capable	Yes
	130 cm		
	130 cm		

Strakha

The only stealth fighter in mass production, the Strakha is a recon ship that relies more on secrecy than firepower. Two meson guns and a duo of lasers serve to defend it from enemy fighters, and a lone Strakha has been known to eliminate four Hellcats in the space of ten minutes.

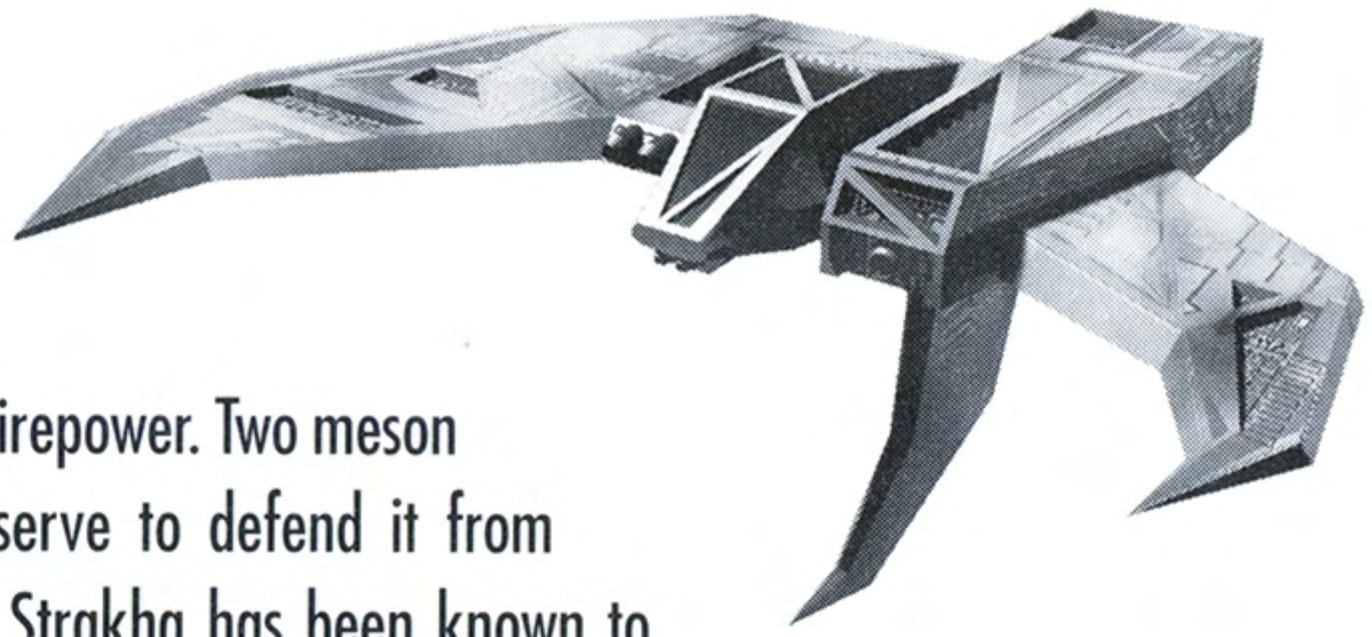

Class	Stealth Fighter	Armor	Fore/Aft:	40 cm
Length	30 meters		Right/Left:	20 cm
Mass	16 metric tonnes	Weapons	Meson gun(2)	
Max. YPR	70/80/70 dps		Laser (2)	
Max. Velocity	480 kps		Missile hardpoints (1 x 5L)	
Max. Afterburn Velocity	1200 kps		5 HS	
Acceleration	250 k/s ²		Missile decoys (6)	
Shields	60 cm equiv.	Jump Capable	No	

Paktahn

The Kilrathi Paktahn is similar to the Longbow by virtue of its torpedo attack capabilities. With mines, missiles, and an impressive array of guns, this bomber can engage several fighters at once during a single run. Terran intelligence reports that Paktahn most often fly with Dralthi or Darket escorts.

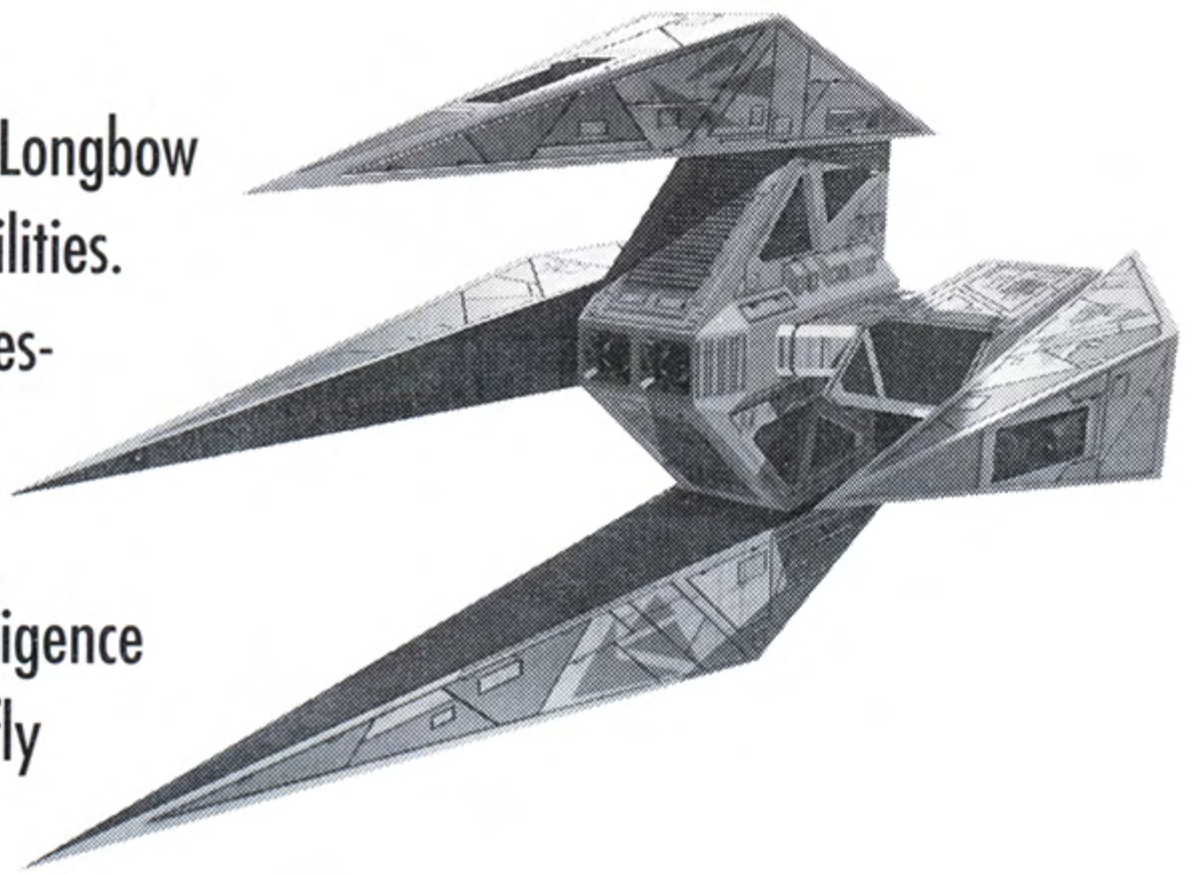

Class	Bomber	Shields	300 cm equiv.	
Length	37 meters	Weapons	Plasma gun (4)	
Mass	30 metric tonnes		Ion cannon (2)	
Max. YPR	40/35/40 dps		Meson blaster rear (1)	
Max. Velocity	340 kps		Torpedo hardpoints (2 x 3)	
Max. Afterburn Velocity	600 kps		Missile hardpoints (2 x 3, 2 x 4)	
Acceleration	100 k/s ²		3 FF / 3 FF / 4 FF / 4 FF	
Armor	Fore/Aft:180/140 cm		Missile decoys (6)	
	Right/Left:	180 cm	Jump Capable	No

INTELL: ENEMY FIGHTER UPDATE

>tcn.victory.intell

Codename: Sorthak

Two weeks ago, a routine naval air transfer ended in the destruction of eighteen fighters, including five Arrows, nine Thunderbolts, and four Longbow bombers. The exact circumstances are unclear, but black box data recovered from the debris indicate that an unusually large Kilrathi fighter attacked the group during its flight to Vega Sector.

Apparently equipped with heavy shields and armor, the ship was described on digital tape as "a cross between a Vaktoth and a destroyer, with massive guns protruding from both the front and rear." Other pilot comments note visible torpedo hardpoints, meson guns and possibly a plasma gun.

More updates will be posted as Terran Intell investigates the incident. In the meantime, all TCN pilots are urged to avoid engaging any unusual enemy vessels. Any sightings should be labeled with codename Sorthak and forwarded immediately to tcn@vega.intell.ships.

KILRATHI CAPITAL SHIPS

It's not easy to destroy a Kilrathi capital ship. But if you have the right armament and know where to strike, you can take out a few during your career.

SHIELDS

Shields on capital ships are generally strong and invulnerable to gunfire. However, some fighters can carry the newly developed Leech missile. Its single-minded purpose is to drain a hole in the shields of a capital ship. Attack fighters can then take advantage of the vulnerable spot and launch missiles or torpedoes through the weak point. Unprotected by shields, the hull is highly vulnerable to this type of attack.

WEAK POINTS

All capital ships have weak points. With the advent of shield-penetration missile technology, other weapons besides torpedoes can now damage capital ships. If you can hit these points with missiles or barrage them with full guns, you'll damage the ship. Vulnerable points of attack include the bridge, the hull, windows and engine exhaust ports. Try to attack so that you have these points in your sights when you launch your missiles.

BEST ORDNANCE

The torpedo is a favored weapon among pilots who constantly attack capital ships. With such a high damage potential, one or two torpedoes can knock out even the largest enemy ship. But before you go in for a torpedo run, use your guns to take out turrets on the surface of the capital ship. With less flak, you'll have a better chance of surviving your torpedo run.

You can also use regular missiles and guns against lighter capital ships (such as corvettes and destroyers), but they don't apply as much damage as torpedoes.

If you don't want to use torpedoes, try loading up all your hardpoints with dumbfires. If you have enough of them, you can easily deliver the same amount of damage as a torpedo — and you won't have to wait for a lock.

Supply Depot

Length	1600 meters
Mass	602,000 metric tonnes
Max. YPR.....	0 dps
Max. Velocity	0 kps
Acceleration	0 k/s ²
Shields	None
Armor	Fore/Aft11,200 cm
	Right/Left11,200 cm
Weapons	None

Starbase

Length	5,200 meters
Mass	722,000 metric tonnes
Max. YPR.....	0 dps
Max. Velocity	0 kps
Acceleration	0 k/s ²
Shields	1000 cm equiv.
Armor	Fore/Aft1000 cm
	Right/Left.....1000 cm
Weapons.....	Laser turret (1)

Corvette

Length	110 meters
Mass.....	5500 metric tonnes
Max. YPR.....	5 dps
Max. Velocity	200 kps
Acceleration	20 k/s ²
Shields	1000 cm equiv.
Armor	Fore/Aft500 cm
	Right/Left.....500 cm
Weapons.....	Laser turret (5)

Cruiser

Length	550 meters
Mass	23,000 metric tonnes
Max. YPR.....	5 dps
Max. Velocity	150 kps
Acceleration	20 k/s ²
Shields	3000 cm equiv.
Armor	Fore/Aft1000 cm
	Right/Left.....1000 cm
Weapons.....	Laser turret (15)

Light Destroyer

Length450 meters
Mass17,000 metric tonnes
Max. YPR.....15 dps
Max. Velocity180 kps
Acceleration100 k/s²
Shields1500 cm equiv.
Armor Fore/Aft1000 cm
 Right/Left.....1000 cm
Weapons.....Laser turret (8)

Heavy Destroyer

Length530 meters
Mass19,000 metric tonnes
Max. YPR.....20 dps
Max. Velocity180 kps
Acceleration200 k/s²
Shields2000 cm equiv.
Armor Fore/Aft1000 cm
 Right/Left.....1000 cm
Weapons.....Laser turret (10)
 Tachyon gun (3)

Transport

Length150 meters
Mass.....2100 metric tonnes
Max. YPR.....5 dps
Max. Velocity100 kps
Acceleration10 k/s²
Shields2000 cm equiv.
Armor Fore/Aft300 cm
 Right/Left.....300 cm
Weapons.....Laser turret (2)

Carrier

Length920 meters
Mass100,000 metric tonnes
Max. YPR.....5 dps
Max. Velocity100 kps
Acceleration10 k/s²
Shields2000 cm equiv.
Armor Fore/Aft1000 cm
 Right/Left.....1000 cm
Weapons.....Laser turret (8)

Dreadnought

Length22,000 meters
Mass290,000 metric tonnes
Max. YPR.....5 dps
Max. Velocity100 kps
Acceleration10 k/s²
Shields8000 cm equiv.
Armor Fore/Aft1500 cm
 Right/Left.....1500 cm
Weapons.....Laser turret (38)

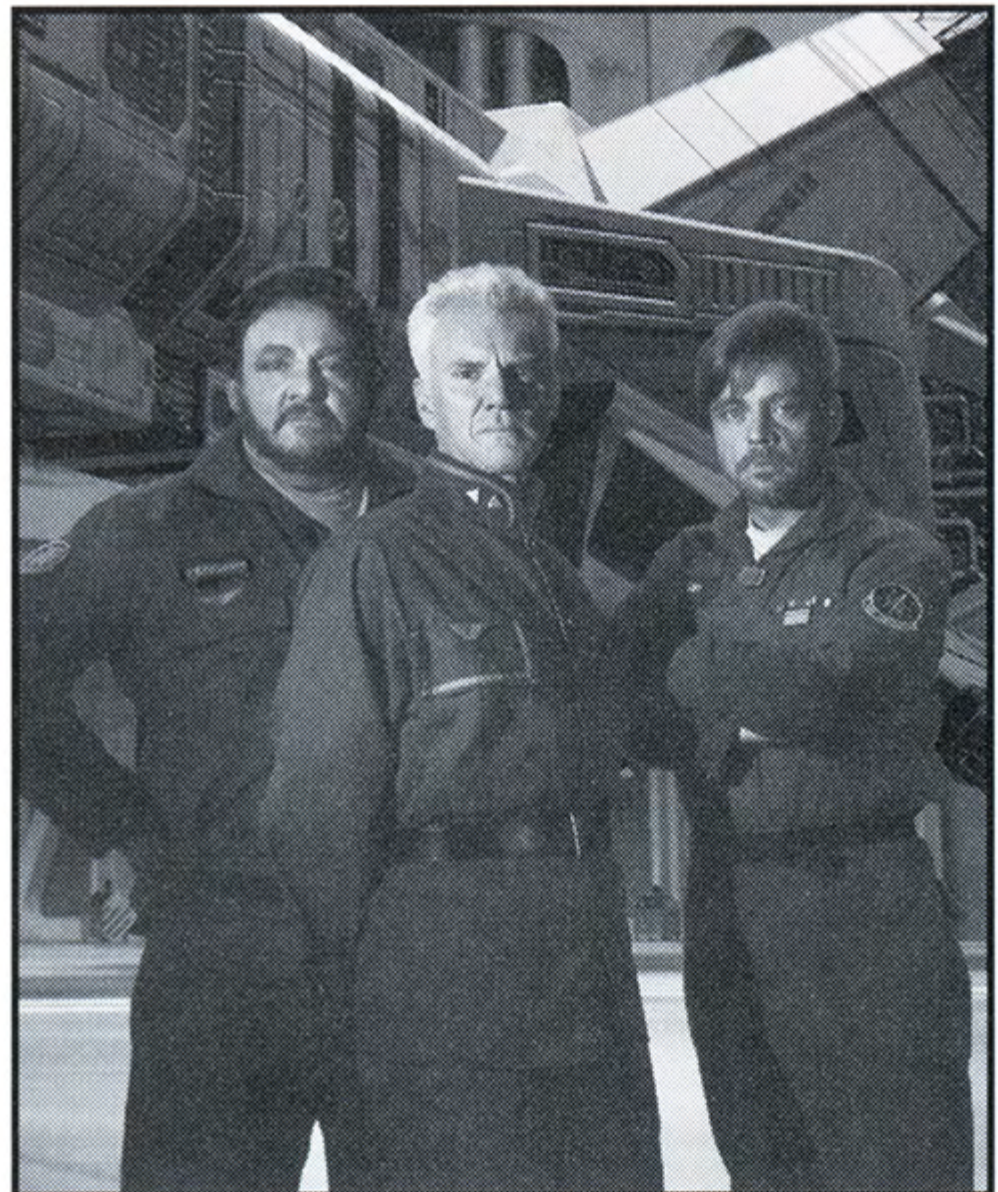

GIF: GUN AND MISSILE STATISTICS

>tcn.victory.flight.weapstat

This GIF describes all gun and weapon capabilities for all fighters and ships in this fleet and is subject to revision at any time. If you have not overwritten your current file in the last six months, it will automatically copy down to your personal databank.

Compiled: 2669.218

Author: Chief Tech Rachel Coriolis

We're not on the front lines, but we still have to protect ourselves against whatever forces the Kilrathi might send. I know these fighters inside and out, and I can tell you how many picoseconds difference there are in lock times for each missile on this "Tin Can Sally."



When I put together this GIF, I was glad to get the chance to offer my 2 credits' worth. Don't take it lightly — I didn't go to flight school just to get my hands greasy, and I'm the one who outfits the rookies.

I've attempted to describe the gun and weapon types you'll find on the *Victory*. Any questions should be directed to rachelc@flight.mun.victory.

GENERAL ORDNANCE INFORMATION

Ship ordnance is categorized into two types — energy guns and weapons. Guns include all multiple-fire blasters that draw energy from a ship's reserves to function. Weapons, on the other hand, include all single-shot munitions, both dumb-mechanism warheads and those equipped with targeting systems. Having observed the enemy for several decades, we've found that Kilrathi forces possess about the same gun and weapon technology as we do.

ENERGY GUNS

All fighters and cap ships in modern fleets use energy guns as their primary armament. Those on fighters are quick-firing and have relatively short range. With the added advantages of high velocity, fast refire rates and advanced guidance systems, hits are virtually guaranteed for any pilot with a few kills under his belt. Cap ship turret guns fall into the same category — keep yourself safely distant from them.

The basic premise of an energy gun is simple — when a hit occurs, massive amounts of energy transfer to the target.

It doesn't take too many shots to down a fighter, but guns are nearly useless against larger ships.

In this section, you'll find descriptions of each gun type and its associated statistics.

Penetration. Armor/shield penetration in tenths of a cm (0.1 cm = 1 armor unit).

Energy. The amount of energy used for one shot (in nano Joules).

Range. Range of the gun (in kilometers).

Refire delay. The gun's optimal recharge rate (in seconds) after each shot.

Ion Cannon

Found mainly on fighters, the ion cannon imparts energy and radiation damage to targets. Charged atomic particles are magnetically accelerated to high speeds, then discharged in pulses. This cannon delivers more damage than a laser and can cause severe pilot injuries. However, the ion cannon has higher energy consumption and a slower refire rate than the laser.

Penetration	24	Range	4500k
Energy	15 nJ	Refire Delay	35 sec

Laser Cannon

The laser provides the standard against which most other blasters are judged. Low maintenance and a low energy cost make it standard armament for almost every ship in existence. The laser is ideally suited to deep-space combat (in atmospheric conditions, rays may refract and lose their effectiveness), and has no effect against shields on larger ships.

Penetration	20	Range	5000k
Energy	7 nJ	Refire delay	25 sec

Meson Blaster

The meson blaster is a unique, powerful gun that utilizes subatomic particles. These particles, called mesons, are accelerated and flung toward a target. The most damage occurs once the particles decay inside the target — they cause internal explosions and give off radiation. Energized shields can stop these particles, and atmospheric conditions render this gun ineffective.

Penetration	28	Range	4500k
Energy	8 nJ	Refire delay	40 sec

Neutron Gun

The neutron gun was specifically created as a weapon for medium and heavy fighters when the war first began. It releases energized blasts of charged neutrons, drawing more power than either the ion cannon or laser. The refire rate for this gun type is slightly slower, but the extended range of the neutron gun more than makes up for the difference.

Penetration	40	Range	4000k
Energy	15 nJ	Refire delay	45 sec

Particle Cannon

The particle cannon uses some of the most significant Terran energy technology. Early prototypes were developed from a similar cannon extracted from a captured Kiltrathi fighter. Engineers built a comparable version capable of hurling minute nuclear particles at high speeds. Impact results in a small nuclear explosion that gives off blast, heat and radiation damage.

Penetration	33	Range	4200k
Energy	11 nJ	Refire delay	40 sec

Photon Cannon

When the Terrans first went to war, the photon cannon was the most popular gun, next to the standard laser. It emits laser pulses and solicits similar effects upon impact. However, the photon cannon drains more energy and has a slower refire rate. This gun requires little maintenance and functions best in deep-space combat.

Penetration	26	Range	4500k
Energy	15 nJ	Refire delay	45 sec

Plasma Gun

The plasma gun was originally developed to attack heavy fighters and corvettes with light armor. It uses electrically charged hydrogen molecules that are in a state of near-fusion. These molecules are similar to those found in the inner plasma of most young stars. Upon impact, plasma projectiles cause radiation, blast and heat damage.

Penetration	54	Range	3000k
Energy	22 nJ	Refire delay	50 sec

Reaper Cannon

(This gun will be available when it completes its test cycle.) The reaper cannon evolved from the standard ion cannon, and its refire rate is slightly faster. This gun delivers high-speed pulses of charged atomic particles that give off energy and radiation damage. Fighters find this gun especially useful against ships with shields that regenerate quickly.

Penetration	28	Range	4500k
Energy	18 nJ	Refire delay	30 sec

Tachyon Gun

The tachyon gun is the most devastating energy gun found on Terran fighters. It slows down tachyon particles, which naturally travel faster than the speed of light. Once these particles are decelerated and forced into streams, their potential damage increases greatly. In several documented cases, the powerful tachyon gun has been used to attack capital ships.

Penetration	56	Range	3200k
Energy	20 nJ	Refire delay	35 sec

MISSILE WEAPONS

Energy guns are the preferred choice for attacking or defending ships and can deliver multiple shots. Missile weapons, on the other hand, have a one-shot life and often use complex guidance systems. Though phased out on larger fleet ships, missiles continue to be a staple among fighters.

Penetration. The penetration of the weapon expressed in armor/shield units.

Speed. The weapon's top speed in kilometers/second.

Acceleration. The acceleration of the weapon in kilometers/second/second.

Maneuverability. Maneuverability of the weapon (pitch, yaw and roll) in degrees/second. (Mines are rated in degrees/minute.)

Duration. The time (in seconds) before the weapon self-destructs.

Lock time. The time (in seconds) the weapon requires to recognize and lock on to the target.

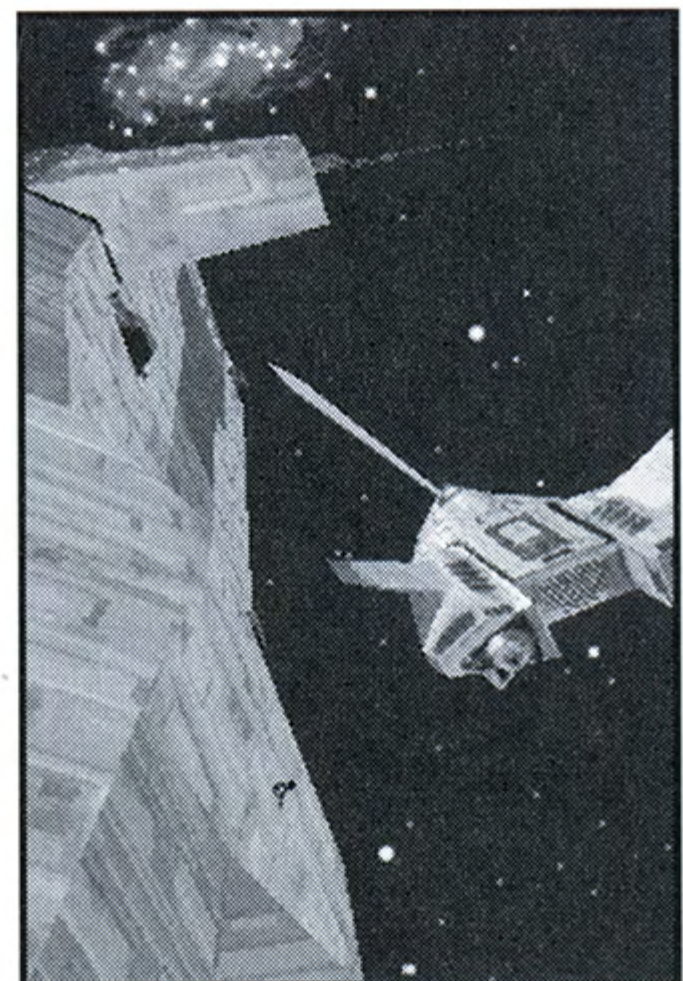

Dart Dumbfire [DF]

Light Hardpoint

A simple weapon, the Dart dumbfire (DF) missile is a point-and-shoot weapon carried on almost every fighter in the Terran fleet. It is unjammable due to the absence of guidance systems, and costs less than any other missile type. The dumbfire doesn't require any type of lock and has no homing capability. Pilots find it most useful against targets with predictable reactions — at close range, a single dumbfire can diminish shields enough to plant a few devastating shots from an energy gun.

Penetration	800	Maneuverability	0 dps
Speed	3750 k/s	Duration	3 sec
Acceleration.....	2000 k/s ²	Lock time	0 sec

Javelin Heat-Seeker [HS]

Light Hardpoint

The Javelin heat-seeker (HS) is an inexpensive, simple weapon that has served in various armed forces since the late 1900s. The engines of fighters and capital ships generate significant heat, a fact that the HS uses to its advantage. The operation is simple — the missile tracks down the thermal signature of the target's engines. This requires the lock to be acquired from the rear. Heat-seekers, along with dumbfire missiles, are the most common missiles carried on fighters.

Penetration	400	Maneuverability	15 dps
Speed	2500 k/s	Duration	10 sec
Acceleration.....	1600 k/s ²	Lock time	2 sec

Leech

Light/Heavy Hardpoint

TCN weapon engineers developed the Leech missile in order to allow smaller fighters to attack capital ships if necessary. The Leech is not an explosive; rather, it is a sophisticated electronic weapon system capable of disrupting a target's power. It temporarily drains power from ships.

Penetration	None	Maneuverability	11 dps
Speed	1000 k/s	Duration	10 sec
Acceleration.....	1000 k/s ²	Lock time	6 sec

Pilum Friend-or-Foe [FF]

Light/Heavy Hardpoint

The Pilum friend-or-foe (FF) missile was developed once ship systems were able to distinguish between friendly and enemy ships. Capable of identifying the distinctive Confederation ship signal, it makes a beeline for the nearest ship that isn't broadcasting that signal. (However, you cannot fire one unless an enemy ship is targeted.) This has resulted in the destruction of several Terran ships whose communications systems

were damaged. In spite of this inherent danger, both sides continue to use the FF as standard armament for medium and heavy fighters. This missile doesn't require a lock, and it will acquire a new target if the current one is destroyed before detonation.

Penetration	250	Maneuverability	15 dps
Speed	1500 k/s	Duration	20 sec
Acceleration.....	1600 k/s ²	Lock time	0 sec

Spiculum Image-Recognition (IR) Light/Heavy Hardpoint

The Spiculum image-recognition (IR) missile uses computer imaging to identify and "memorize" a targeted ship. Once the IR is launched, electronic and visual signatures specific to that target are copied to the missile's AI program. The IR is extremely difficult to evade and poses no danger to friendly ships.

Penetration	350	Maneuverability	15 dps
Speed	2000 k/s	Duration	15 sec
Acceleration.....	1200 k/s ²	Lock time	1 sec

Mine Light/Heavy Hardpoint

A mine is a stationary or slow-moving variant of a missile. Although non-descript, it's useful for booby-trapping areas that the enemy may pass through — jump points, gaps in asteroid fields and pulsar shadows. Some mines also have simplified guidance systems that can seek out disabled ships. Since mines move so slowly, ship detection systems are unable to track them with sensors or radar. Because of the danger of friendly casualties, most mines are now set to self-destruct after a 30-minute active period.

Penetration	100	Maneuverability	20 dps
Speed	20 k/s	Duration	30 min
Acceleration.....	200 k/s ²	Lock time	0 sec

Torpedo

The torpedo is a large, maneuverable warhead used against capital ships and bases. It has a built-in image-recognition system that locks onto the target, and even laser turrets can't shoot it down. Its lock time is longer than that of any other missile, but the torpedo is the only fighter weapon that can easily destroy carriers.

Penetration	8000	Maneuverability	10 dps
Speed	1000 k/s	Duration	14 sec
Acceleration.....	400 k/s ²	Lock time	12 sec

CAPITAL SHIP WEAPONS

Capital ships, including the *Victory* and its counterparts, rely on energy guns just as much as fighters do. They support fleet actions with stepped-up versions of those found on many popular fighters, including the tachyon gun, particle cannon and laser cannon.

Anti-Matter Gun (AMG)

The anti-matter gun comprises the secondary armament of most friendly and enemy capital ships. This weapon can punch through the heaviest shields, and it delivers four times as much damage as the most powerful gun on any fighter. Capital ships rely on the anti-matter gun to defend against corvettes, heavy fighters and bombers that are attacking.

Penetration	300	Range	8000k
Energy	130 nJ	Refire delay	1.5 sec

Laser Turret

Capital ships are especially vulnerable to concentrated fighter attacks. For this reason, laser turret guns were mounted to provide point-defense for particular ship surfaces. This weapon can engage light fighters and destroy incoming missiles. The capital-ship version of the laser can hit a fighter with twice the normal damage (two regular lasers are mounted on each turret).

Penetration	60	Range	3000k
Energy	15 nJ	Refire delay	2 sec

CapShip (CS) Missile

This huge, lockable missile carries a powerful anti-matter warhead capable of taking out other capital ships and tactical planetary targets. The CapShip missile is found mostly on the launch racks of older ships.

Penetration.....	60,000	Maneuverability	20 dps
Speed	1000 k/s	Duration	120 sec
Acceleration.....	400 k/s ²	Lock time.....	5.0 sec

Wing Commander III PlayStation Game Console Credits

Executive ProducersPaul Grace, Dallas Snell
 Producer.....Michael Kosaka
 Assistant ProducersPhil Engstrom, Ana Moreno
 Development Leaders.....Nana Chambers, Scott Cronce
 ProgrammingSteve Coalier, Ken Hurley,
 Trevor Jalowitz, Kurt Schallitz, Carolyn Wales
 GraphicsLaura Bowen, Nick Corea,
 Gary Martin, Michael Shirley
 Audio.....Tony Berkeley, Ken Felton,
 Rob Hubbard, Don Veca, David Whittaker
 VideoJeni Day, Ken Dyke, Eric Kornblum, Jeff Litz

Electronic Arts Product Support, San Mateo

Game TestersDaniel Breiz, Alex DiRocco, Tony Easley,
 Phil Engstrom, Michael Lubuguin, Don Rottiers
 Rick Andrakin, Ben Lopez, Chris Bennett,
 Mike Silva, Joanna Pataki, Steve Imes

ORIGIN Product Support

Product Support ManagerKay Gilmore
 QA SupervisorEvan Brandt
 QA Project LeaderChristian Primozich
 Translations Liaison.....David Abelt
 Game TestersJames Flores, Sam Arnold, Chuck Lupher,
 Grant McDaniel, Kirk Watson, Ron Blancarte, Allen Jackson.

ORIGIN Marketing

Product ManagerGalen Svanas
 DocumentationTuesday Frase
 EditingDavid Ladyman
 Document TranslationIsabelle Rice, Anja Rumbarger
 Packaging DesignTrey Hermann, Robin McShaffry
 Document DesignCatherine Cantieri

PC Credits

Game Development

ProducerChris Roberts
 Director.....Frank Savage
 Associate ProducersPrem Krishnan, Jean-Marc Chemla

Cast:

Col. Christopher Blair.....Mark Hamill
 Admiral Tolwyn.....Malcolm McDowell
 Maj. James "Paladin" TaggartJohn Rhys-Davies
 Capt. William EisenJason Bernard
 Maj. Todd "Maniac" Marshall.....Tom Wilson
 Chief Tech Rachel Coriolis.....Ginger Lynn Allen

Lt. Robin "Flint" Peters.....Jennifer MacDonald
 Lt. Ted "Radio" Rollins.....Courtney Gains
 Lt. Winston "Vagabond" ChangFrancois Chau
 Lt. Laurel "Cobra" Buckley.....B.J. Jefferson
 Maj. Jace "Flash" DillonJoshua Lucas
 Lt. Mitchell "Vaquero" LopezJulian Reyes
 Col. Jeanette "Angel" DevereauxYolanda Jilot
 NewscasterBarbara Niven
 Bartender.....J.P. Perea
 Voice of Thrakhath.....John Rhys-Davies
 Voice of Melek.....Tim Curry
 Voice of EmperorAlan Mandell
 Voice of Hobbes.....John Schuck

Audio

Interactive Sound DesignNenad Vugrinec
 NIM Interactive MusicGeorge Oldziej, Nenad Vugrinec
 Spaceflight Dialogue Editor.....Barry Leitch
 Sound System byHuman Machine Interfaces, Inc.
 Digital & MIDI Sound EngineAaron Martin,
 John Reeme, Frank Savage

Art

Art DirectorChris Douglas
 Assistant Art DirectorPaul Steed
 3-D ArtistsChris Douglas, Mark Vearrier,
 James Lee, Thomas Lee, Chris Olivia, J.C. Combs,
 Alan Perez, Craig Halverson, Steve Pietzsch
 RealSpace ObjectsPaul Steed, Dean McCall,
 Michael Presley, Elizabeth Foster Pugh,
 Sam Laskowski, Jeff Shelton, Tim Ray, Ben Potter
 Mission Briefing AnimationsDanny Garrett, Eric Lund,
 Dicko Mather, Brian McLean, Gary McElhaney,
 Elizabeth Foster Pugh, Jake Rodgers, Paul Steed
 Gameflow Option Screens.....Brian McLean
 Mark Vearrier, Chris Douglas
 Cockpit DisplaysElizabeth Foster Pugh, Jennifer Ayers
 3-D Software provided by Alias Research
 Graphics Hardware provided by Silicon Graphics

Movie Production

Executive Producer & Director.....Chris Roberts
 Producer.....Donna Burkons
 ScreenplayTerry Borst, Frank De Palma
 Casting DirectorNicole Arbusto, Joy Dickson
 1st Assistant DirectorHarry Jarvis
 2nd Assistant DirectorAthena Alexander
 2nd 2nd Assistant DirectorTia Ardran
 Production ManagerPam Auer
 Technical DirectorMark Day

Director of Photography	Virgil Harper	EA Productions Accountant	Tracey Snodgrass
Assistant Camera Operator	Tom Kantrud	EA Finance & Insurance	Bryan Neider, Sharon Warmboe
Ultimatte Operator	Bob Kertesz	Production Accountant	Laurel Richter
Ultimatte Assistant	Greg Noyes	Talent Paymaster	Karen Kodet
Sound Mixer	Walt Martin	Pre-Production Manager	Richard Johnson
Boom Operator	Paul Coogan	Asst. Pre-Production Manager	Adam Foshko
Script Supervisor	Kate Lewis	Assistant to the Director	John McLean
Storyboard Artist	Marc Baird	Publicity provided by	The Villines Company
Set Designer	Cherie Baker	Unit Publicist	Morgan Moore
Gaffer	Reggie Lake	Mark Hamill's Stand-In	Emidio Antonio
Best Boy Electric	Robert Neville	Malcolm McDowell's Stand-In	Chief Gordon
Rigging Gaffer	Eddie Maloney	Production Assistants	Jim Capp, Kirsten Maryott, Laurie Boykoff
Electrician	Shaun Goldsmith	Craft Service	Laura Bagano , Juana Martinez, Michael Foxworth
Key Grip	Gus Vasquez	Talent trailers provided by	Star Wagons
Best Boy Grip	Greg Etheredge	Sound Stages provided by	Hayvenhurst Studios
Grips	Jim Coker, Kevin Cook, John Martin, Shane Brott, Jeff Murrell	Post-Production	
Props	Josh Logan	Post-Production Director	Phillip Gessert
Prop Master	Tamara Clinard	Austin Post-Production Supervisor	Adam Foshko
Dresser	Todd Szabo	S.F. Post-Production Supervisor	Mark Day
Hair	Lana Sharpe	Post-Production Coordinator	David Downing
Makeup	Bill Myer, Kim Miner	Sound	
Wardrobe	Mary Paxton, Krista Schluderman	Audio Director	Martin Galway
Set Costumer	Nan Gail	S.F. Audio Supervisor	Murray Allen
Construction Coordinator	Mike Clark	Original Score	George Oldziej
Construction	Shane Middleton	Re-Recording Mixers	Tony Berkeley, Ken Felton
Kilrathi Puppets/Props provided by	Precision Effects	Dialogue Editing	Tony Berkeley, Ken Felton
Creature Suit Supervisor	John Parsons	Asst. Dialogue Editor	Jeni Day
Suit Operators	Michael Hood, Billy Butler Chris Bergschneider, Randy Harvey	Foley Editing	Tony Berkeley, Ken Felton
Creature Suit Technicians	Rick Cedillo, Terri Fluker, Ron Ford, Alex Mindt, Gloria Munoz	Music Editing	Randy Buck, Tony Berkeley, Ken Felton
Asst. Creature Suit Technicians	Linda Newman Wendel Phillips, Mike Walters	Music Recording	Randy Buck
Precision Effects P.A.	Karen Carmichael	Supervising Sound Effects Editor	Randy Buck
Puppeteer	Bud McGrew	Sound Effects Editor	Jason Cobb
Puppeteer Assistant	Kass Nassiri, Mike Newman	Sound Designers	Stretch Williams, Britt Daniel Marc Farly, Nenad Vugrinec
2nd Unit Director	Richard Johnson	Special Kilrathi Vocal Effects	Tom Seufert
2nd Unit Director of Photography	Bill Sheehy	Contributing Composer	Paul Baker
2nd Unit Ultimatte Operator	Tom Tcimpidis	OSI Foley Artists	Stretch Williams, Britt Daniel, Jason Cobb
2nd Unit Gaffer	Henry Coccetti	Foley Guitar by	Stretch Williams
2nd Unit Script Supervisor	John McLean	OSI Foley Recordists	Randy Buck, Jason Cobb
2nd Unit Sound Mixer	Mary Jo Devenney	Foley & ADR services provided by	Post Sound Corp.
Pyrotechnic Effects	Dream Quest Images	Foley & ADR Mixer	Kris Campbell
Pyrotechnic Supervisor	Robert Stadd	Foley Artist	Pamela Kahn
Pyrotechnic Shoot Director	Adam Foshko	Additional Voice-Overs	Jennie Evans, Tuesday Frase, Lisa Acton
EA Productions Counsel	Carol Contes		

ORIGIN SYSTEMS, INC. LIMITED 90-DAY WARRANTY

ORIGIN warrants to the original purchaser of this computer software product that the recording medium on which the software programs are recorded will be free from defects in material and workmanship for 90 days from the date of purchase.

If the recording medium is found defective within 90 days of original purchase, ORIGIN agrees to replace, free of charge, any such product upon receipt at its Factory Service Center of the product, postage paid, with proof of date of purchase. This warranty is limited to the recording medium containing the software program originally provided by ORIGIN. This warranty shall not be applicable and shall be void if the defect has arisen through abuse, mistreatment or neglect. Any implied warranties applicable to this product are limited to the 90-day period described above. If failure of the software product, in the judgment of ORIGIN, resulted from accident, abuse, mistreatment or neglect, or if the recording medium should fail after the original 90-day warranty period has expired, you may return the software program to ORIGIN, at the address noted below, with a check or money order for \$5.00 (U.S. currency), which includes postage and handling, and ORIGIN will mail a replacement to you. To receive a replacement, you should enclose the defective medium (including the original product label) in protective packaging accompanied by: (1) a \$5.00 check (2) a brief statement describing the defect and (3) your return address. Canada and Foreign Orders Note: Only U.S. money orders are accepted.

Except as set forth above, this warranty is in lieu of all other warranties, whether oral or written, express or implied, including any warrant of merchantability or fitness for a particular purpose, and no other representation of claims of any nature shall be binding on or obligate ORIGIN. In no event will ORIGIN be liable for special, incidental or consequential damage resulting from possession, use or malfunction of this product, including damage to property and to the extent permitted by law, damages for personal injury, even if ORIGIN has been advised of the possibility for such damages. Some states do not allow limitations on how long an implied warranty lasts and/or the exclusion or limitation of incidental or consequential damages, so the above limitation and/or exclusion or limitation of liability may not apply to you. This warranty gives you specific legal rights. You may have other rights that vary from state to state.

ORIGIN PRODUCT SUPPORT

To contact ORIGIN Product Support:, call (512) 434-HELP (434-4357), Monday through Friday, between 9 a.m. and 1 p.m., or 2 p.m. and 5 p.m., Central time (2 p.m. to 4:30 p.m., Friday afternoons).

Fax ORIGIN at: (512) 795-8014

Write to: ORIGIN Systems, Inc. • 5918 West Courtyard Drive • Austin, TX 78730

ONLINE SERVICES AND BULLETIN BOARDS

America Online. You can e-mail Customer Support at ORIGINCS. To reach our Customer Support and Marketing boards in the Industry Connection, press **Ctrl****K** for "Go to Keyword." Then, type ORIGIN in the Keyword window. In addition to reading messages, you can download files from the "Origin Software Library."

CompuServe. To reach our Customer Support and Marketing boards in the Game Publishers Forum, type GO GAMAPUB at any "!" prompt. Then select the Origin Section (Section 12). You can read messages and download files from the "Library Files" menu. Reach Customer Service at 76004,2612 (or post a message in the Origin Game Publishers' Section). Contact the Marketing department at 71333,136.

ORIGIN BBS. The ORIGIN BBS in Austin, Texas has a modem support of: 300/1200/2400/9600/14,400 baud at 8 bit, no parity, 1 stop bit. It operates 24 hours a day, 7 days a week. Call 512-346-2BBS (346-2227) to contact. No membership is required and the only cost is any long distance charges.

Internet. You can e-mail your technical support and upgrade questions to ORIGIN Customer Support at support@origin.ea.com. To reach the Marketing department, send e-mail to marketing@origin.ea.com.

You can also retrieve demos, patches, press releases and screen shots from ORIGIN's anonymous FTP site at ftp.ea.com. Look in the \pubs\ directory.

Check out the ORIGIN World Wide Web page at <http://www.ea.com/origin.html>.

ORIGIN Systems Inc. 5918 West Courtyard Drive Austin, Texas 78730

© 1996, ORIGIN Systems, Inc. Heart of the Tiger and Origin Interactive Movie are trademarks of ORIGIN Systems, Inc. Origin, We create worlds and Wing Commander are registered trademarks of ORIGIN Systems, Inc. Electronic Arts is a registered trademark of Electronic Arts.

Licensed by Sony Computer Entertainment America for use with the PlayStation game console. PlayStation and the PlayStation logos are trademarks of Sony Computer Entertainment Inc. The ratings icon is a registered trademark of the Interactive Digital Software Association. Manufactured and printed in U.S.A. THIS SOFTWARE IS COMPATIBLE WITH PLAYSTATION GAME CONSOLES WITH THE NTSC U/C DESIGNATION.

U.S. and foreign patents pending.

1011005