



NTSC U/C

PlayStation™

RIDGE RACER®



SCUS-94300
94300



WARNING: READ BEFORE USING YOUR PLAYSTATION GAME CONSOLE:

A very small percentage of individuals may experience epileptic seizures when exposed to certain light patterns or flashing lights. Exposure to certain patterns or backgrounds on a television screen or while playing video games, including games played on PlayStation game console, may induce an epileptic seizure in these individuals. Certain conditions may induce previously undetected epileptic symptoms even in persons who have no history of prior seizures or epilepsy. If you, or anyone in your family, has an epileptic condition, consult your physician prior to playing. If you experience any of the following symptoms while playing a video game – dizziness, altered vision, eye or muscle twitches, loss of awareness, disorientation, any involuntary movement, or convulsions – IMMEDIATELY discontinue use and consult your physician before resuming play.

WARNING TO OWNERS OF PROJECTION TELEVISIONS:

Still pictures or images may cause permanent picture-tube damage or mark the phosphor of the CRT, avoid repeated or extended use of video games on large-screen projection televisions. Refer to your projection TV instruction manual for more details.

HANDLING YOUR PLAYSTATION DISC:

- This compact disc is intended for use only with PlayStation game console.
- Do not bend it, crush it or submerge it in liquids.
- Do not leave it in direct sunlight or near a radiator or other source of heat.
- Be sure to take an occasional rest break during extended play.
- Keep this compact disc clean. Always hold the disc by the edges and keep it in its protective case when not in use. Clean the disc with a lint-free, soft, dry cloth, wiping in straight lines from center to outer edge. Never use solvents or abrasive cleaners.

Set up your PlayStation game console according to the instructions in its Instruction Manual. Make sure PlayStation power is off before inserting or removing a compact disc. Insert the Ridge Racer disc and close the CD door. Insert game controllers and turn on PlayStation. Follow on-screen instructions to start a game.

Console

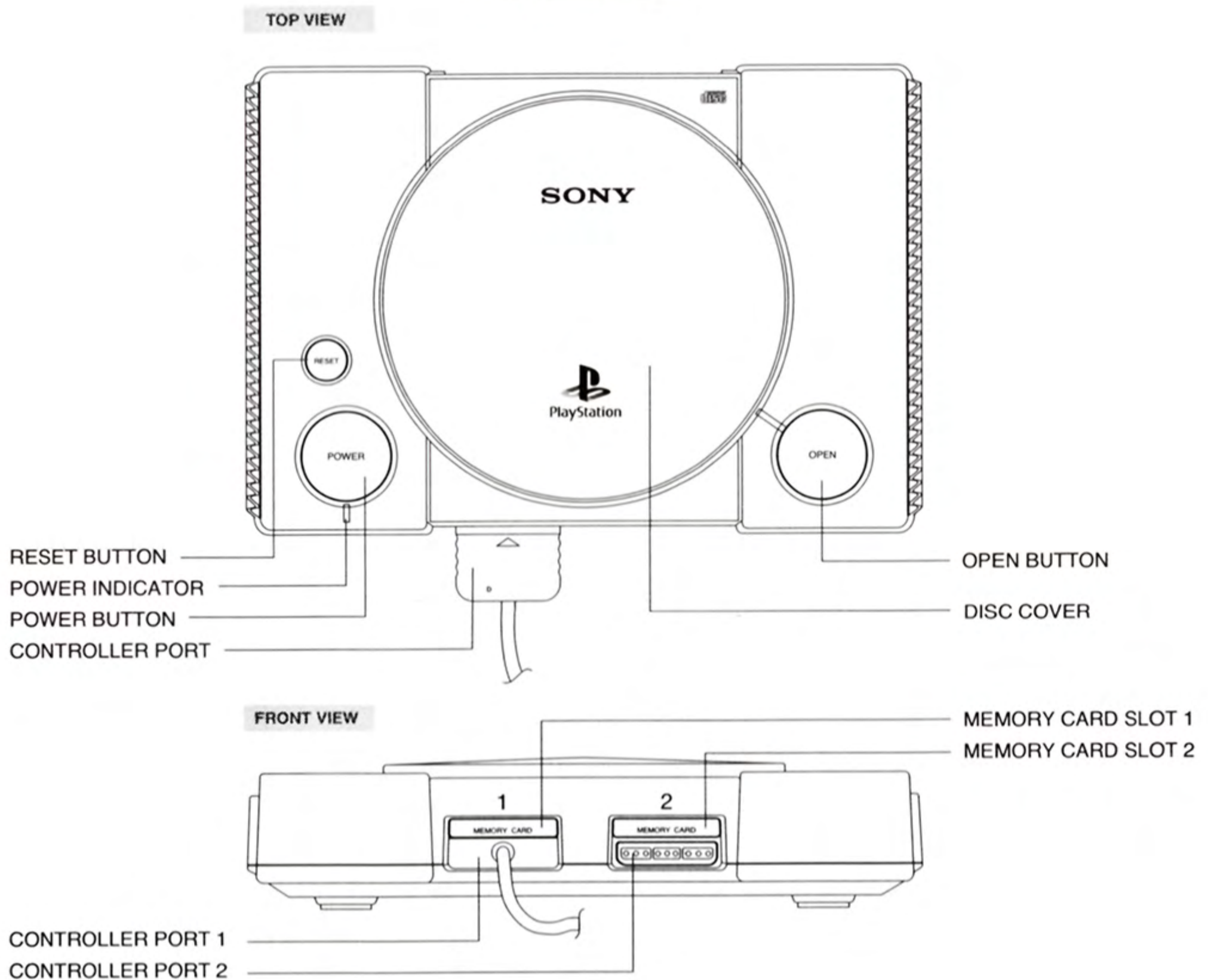

Controller

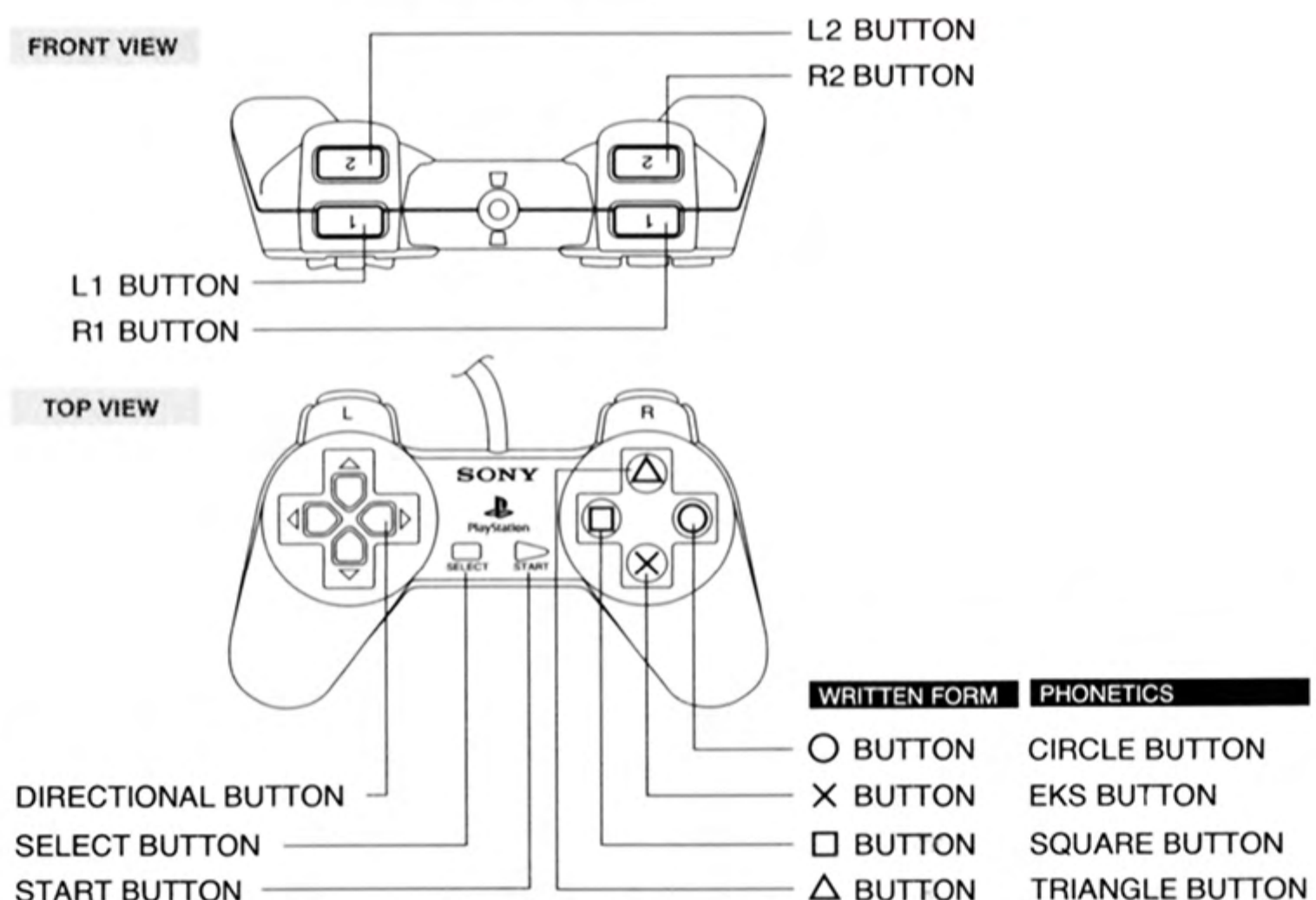

STARTING THE GAME



When you insert the disc, the "Ridge Racer" Title Screen will be displayed. Follow the messages and press the Start Button. When you press it, the Game Mode Selection Screen will come up. At this screen you can choose a variety of play settings.

SETTING THE PLAY MODE

The items you can choose from at the Game Mode Selection Screen are: Transmission, Music, Course and Car. When you finish choosing, press the Start Button and the game will start. If you choose Option, the Option Selection Screen will come up.

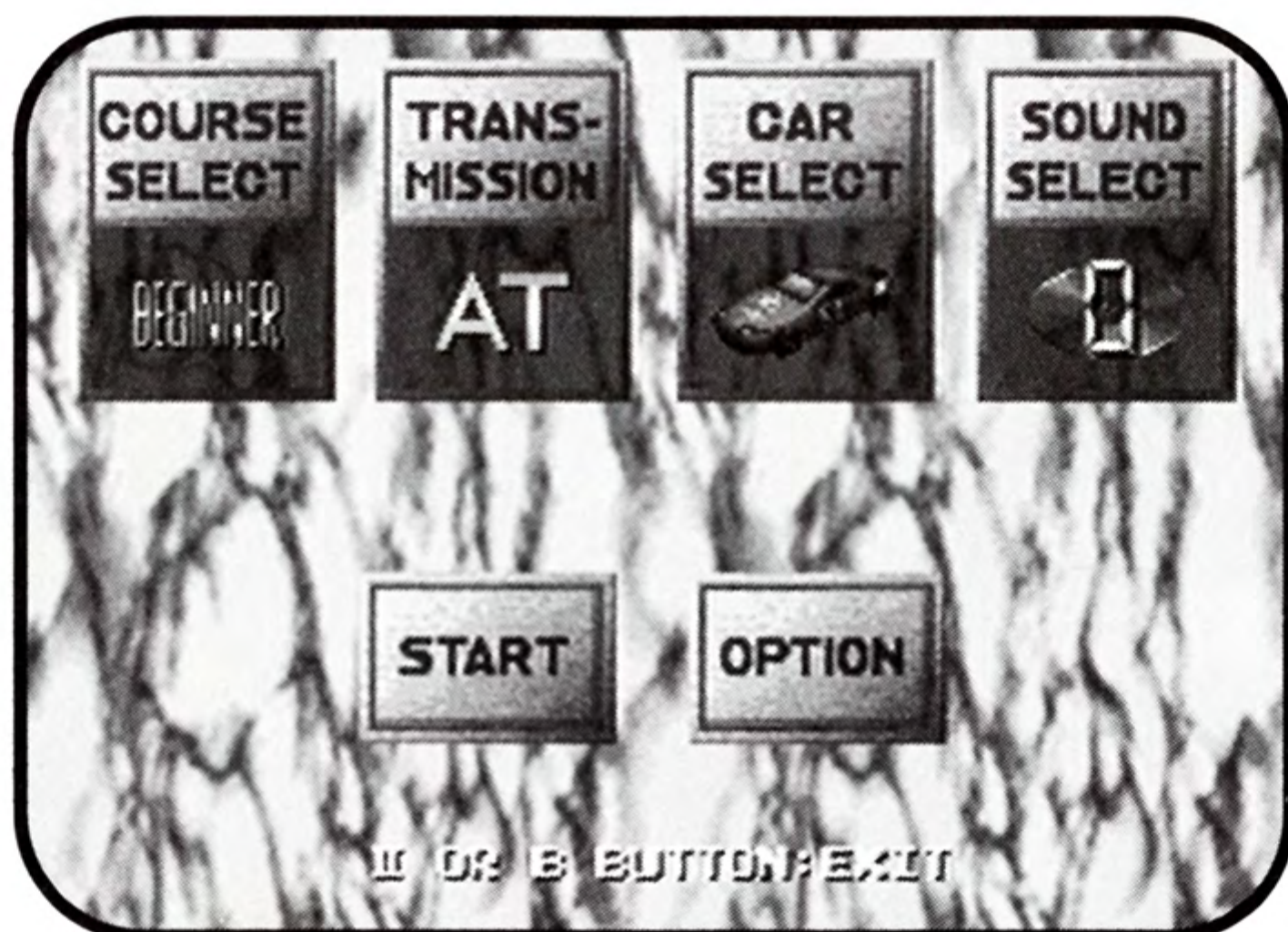

CHOOSING A TRANSMISSION

Automatic – The gears will shift automatically to match the speed. This is good for beginners.

Manual – You can freely change the gears yourself. This is good for experts.

CHOOSING MUSIC

Sound Select – You can choose the Music that runs during game play. Also you can enjoy playing just the music by choosing the Music Player Mode Option.

CHOOSING A COURSE

Beginner – This mode is the simplest for beginners and has two laps. The car's top speed is held down, control is easy and the time limit is set longer. Try out this course first.

Mid-level – This course has three laps and the top speed of the car is increased. It is a little harder to control than the beginner's level. When you can easily finish the beginner's level, try this one.

High-level – The top speed is the same as the intermediate level and there are three laps. However, the road is more narrow and a technical section with more sharp curves is added. Also, the time limit is shorter and the settings are more difficult.

TIME TRIAL – This is a one-on-one time trial against the computer. Your top speed is the fastest of all the modes and control is much more difficult. This course is similar to the expert course.

CHOOSING YOUR CAR

To move through the car selections, press the left and right direction keys. To select a car press the [O] button.



BEGINNER

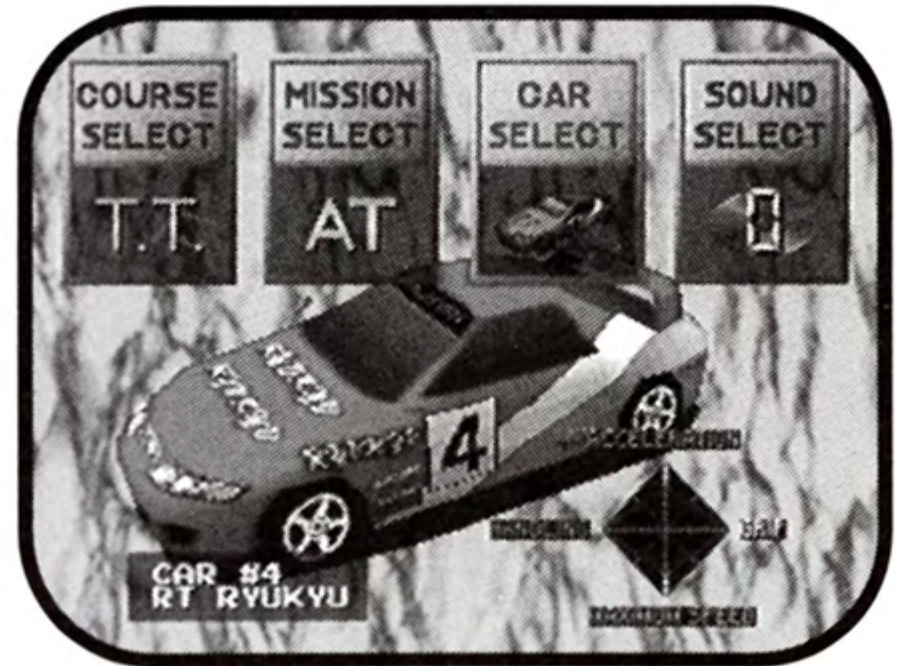

MID-LEVEL



HIGH-LEVEL

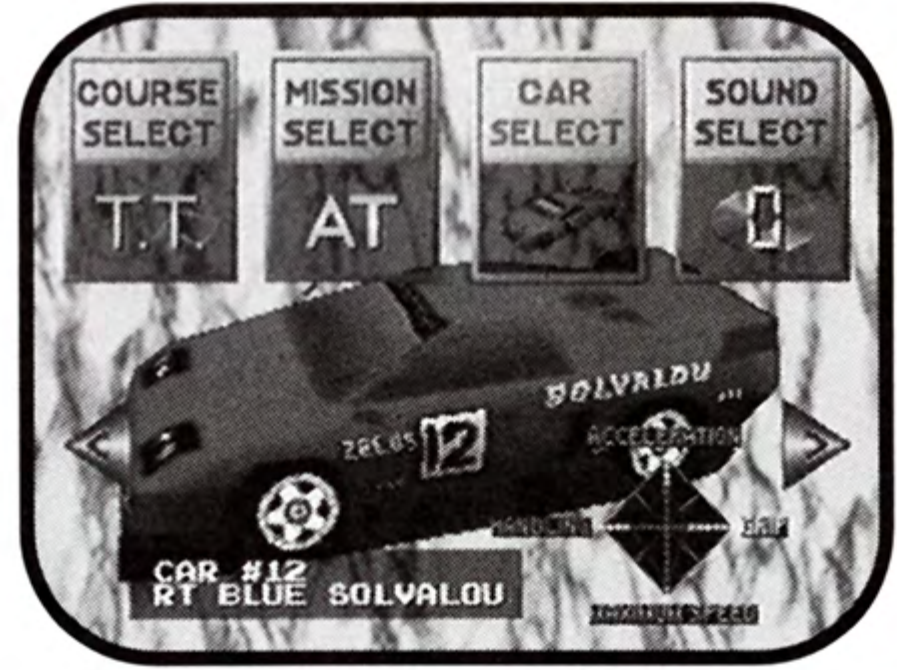

TIME TRIAL

SETTING OPTIONS

If you choose Option at the Game Mode Selection Screen, the Option Selection Screen will come up. You can choose the following three items in the Option Mode:



CONFIRMATION OF RACE RECORDING

Fastest Laps – This records the best times from the time trials. The best lap time is also recorded.



Ranking – Your position in the time trial.

Name – The recorded name of the racer.

Total Time – The total time for three laps.

Type of Car – The type of car used.

Best Lap Time – The highest speed time for one lap.

Note: You need a memory card (sold separately) to store the record.

PLAYING MUSIC

Music player – You can freely select and play music during game play.

If you press the X or O Button the Option Screen will return. Then press the cancel button to return to the Game Mode Selection Screen.

VIEWPOINT

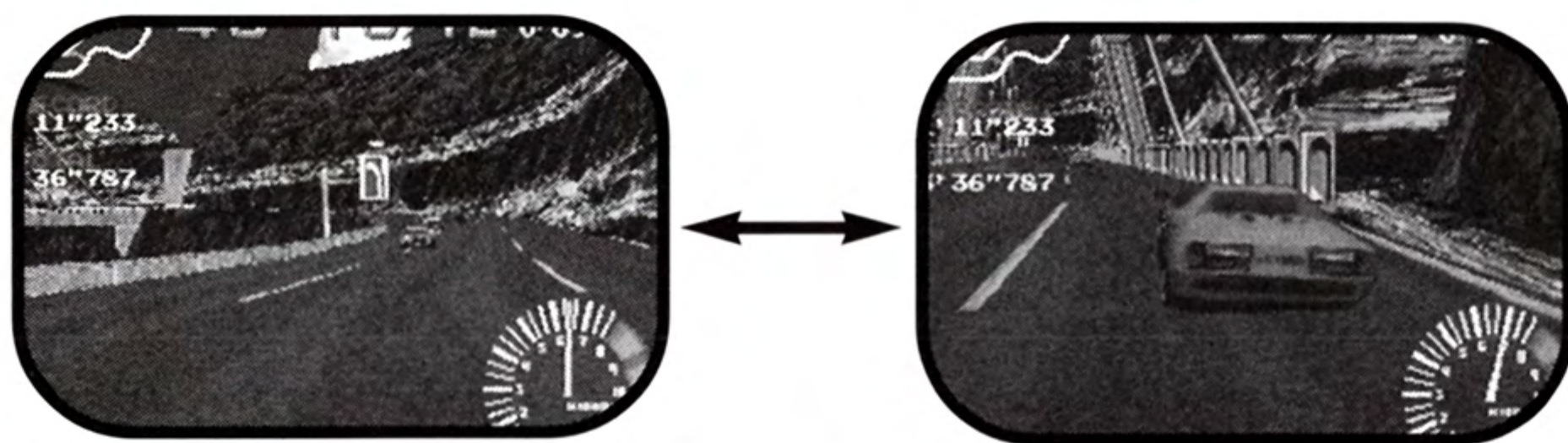

When you press the ▲ Button while racing, the racing perspective changes

BUTTON CONFIGURATION

Choose the mode of operation that best suits you when you play.

SPECIAL STRATEGY- HOW TO MASTER DRIFTING

Drifting is the technique of turning corners while the rear wheels slide. If you master it you can turn beautifully. Here we will present a simple drifting method.



Before the curve, remove your foot from the gas pedal for an instant and brake.



If you step on the gas pedal while giving the steering wheel a big turn, you will start to drift.

USING THE STANDARD CONTROLLER

Left and right Direction Keys – Use to turn the steering wheel left and right while racing. Use for cursor movement when making selections.

Start Button – Use to pause, restart, or exit race.

R1 and R2 Buttons – Use to shift up while racing.

L1 and L2 Buttons – Use to shift down while racing.



DEFAULT SETTING

▲ **Button** – Use it to change views and to cancel when making selections.

● **Button** – Use it to select options.

X **Button** – Use it to accelerate and to select options.

■ **Button** – Use it to brake and cancel selections.

EXPLANATION OF THE SCREEN/RULES

Lap time – Displays the lap time for each circuit.

Ranking – Displays current ranking.

Time Left – Displays the time left. When it reaches zero the game ends. If you pass the check point within the allotted time, the remaining time will be added to the next lap.

Map – Displays the course and your car's position. The red arrow indicates your car and the yellow one the top car.

Best Time – The fastest lap time recorded in the race up to now.

Total – The fastest total time up to now.

Gear Position Display – Displays what gear you are in.

Tachometer – A meter that displays the engine revolutions.

Speed Indicator – Displays the current speed.

If you press the Start Button during the game, Cancel/Restart/Exit will be displayed. Choose a Direction Key and press Start again.

Cancel: cancels pause.

Restart: runs the course again.

Exit: returns you to the Game Mode Selection Screen.



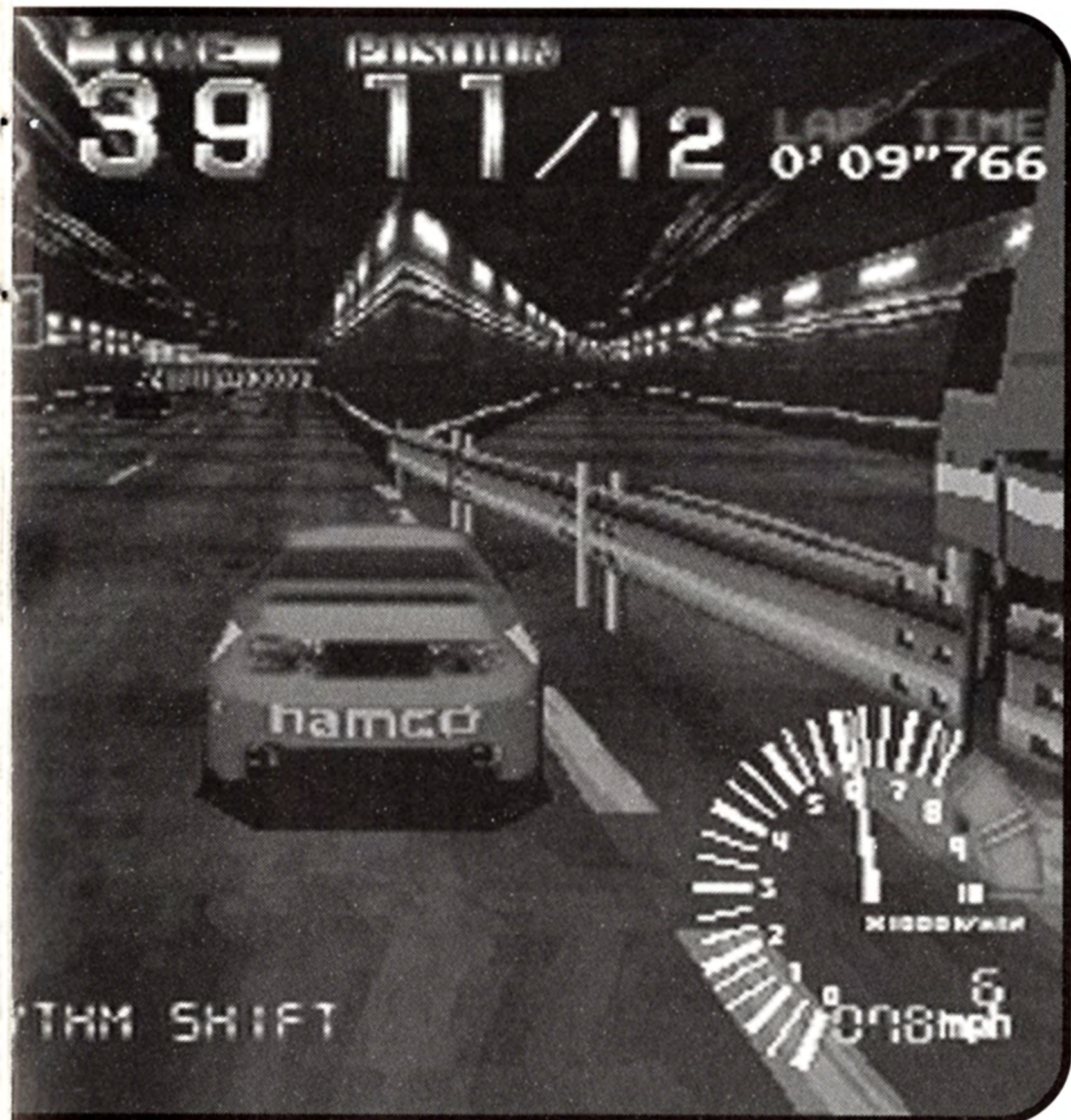

LIMITED WARRANTY

Namco Hometek, Inc. warrants to the original purchaser that this Namco Hometek, Inc. game pak shall be free from defects in material and workmanship for a period of ninety (90) days from the date of purchase. If a defect covered by this limited warranty occurs during this 90-day limited warranty period, Namco Hometek, Inc. will repair or replace the defective game pak or component part, at its option, free of charge.

This limited warranty does not apply if the defects have been caused by negligence, accident, unreasonable use, modification, tampering, or any other cause not related to defective material or workmanship.

LIMITATIONS ON WARRANTY

Any applicable implied warranties of merchantability and fitness for a particular purpose, are hereby limited to ninety (90) days from the date of purchase and are subject to the conditions set forth herein. In no event shall Namco Hometek, Inc. be liable for consequential or incidental damages resulting from the possession or use of this product.

The provisions of the limited warranty are valid in the United States only. Some states do not allow limitations on how long an implied warranty lasts, or exclusion of consequential or incidental damages, so the above limitation or exclusion may not apply to you. This limited warranty provides you with specific legal rights. You may have other rights which vary from state to state.

Namco Hometek, Inc.
150 Charcot Avenue, Suite A
San Jose, CA 95131-1102
408-922-0712



PlayStation™

NTSC U/C

PlayStation™

RIDGE RACER®

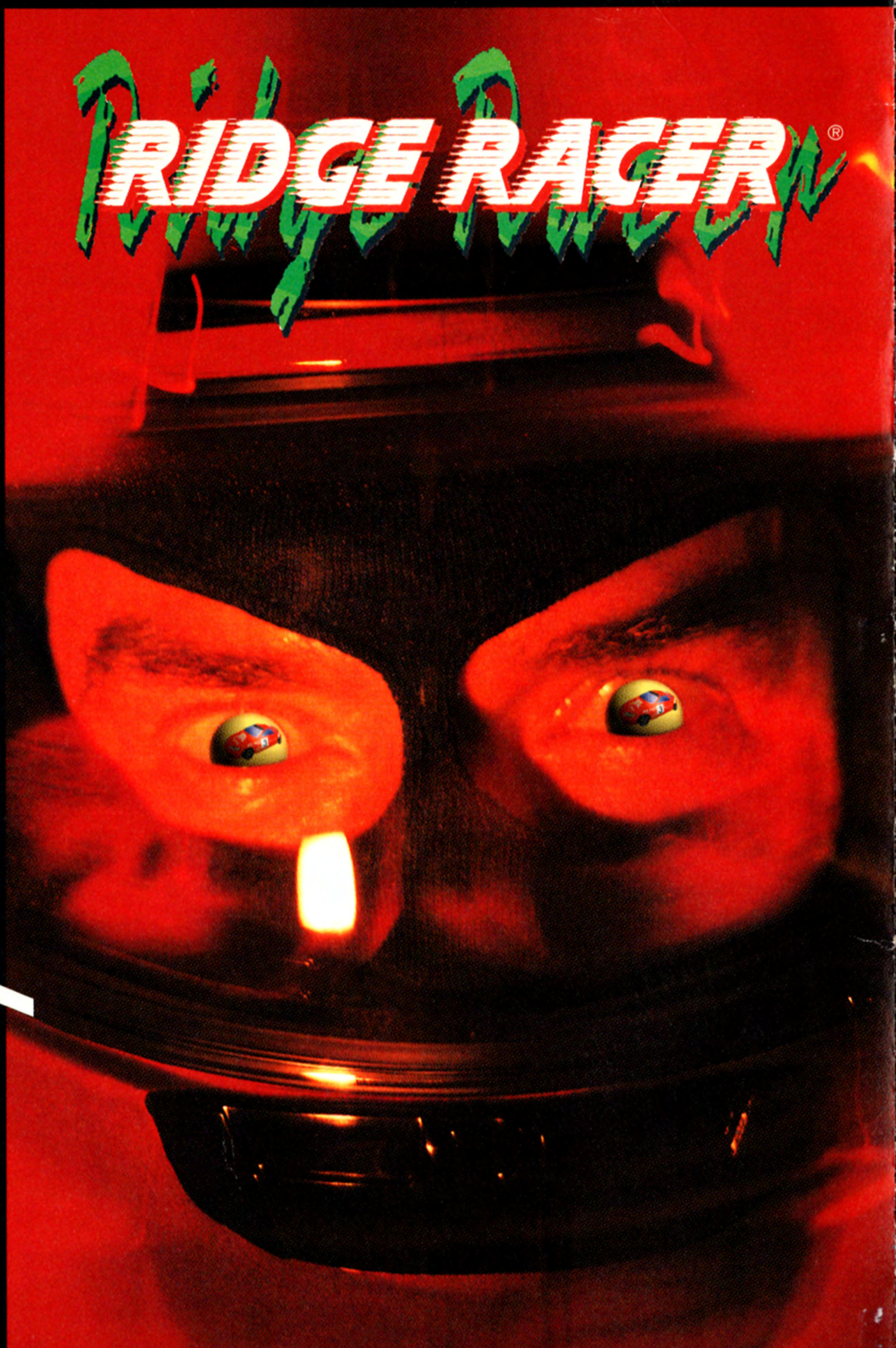

NAMCO HOMETEK, INC., 150 CHARCOT AVE., SUITE A, SAN JOSE, CA 95131
© & © 1993 1994 Namco Ltd. All rights reserved.
Manufactured pursuant to license with Namco-America, Inc.



PlayStation and the PlayStation logos are trademarks of Sony Computer Entertainment Inc.
The ratings icon is a registered trademark of the Interactive Digital Software Association.

U.S. and foreign patents pending.

SCUS-94300
94300